

Oracle ZFS Storage: The Best-of-Breed Solution for Highly Scalable Oracle Cloud

December, 2023, Version [\[1.0\]](#)
Copyright © 2024, Oracle and/or its affiliates
Public

Disclaimer

This document in any form, software, or printed matter, contains proprietary information that is the exclusive property of Oracle. Your access to and use of this confidential material is subject to the terms and conditions of your Oracle software license and service agreement, which has been executed and with which you agree to comply. This document and information contained herein may not be disclosed, copied, reproduced, or distributed to anyone outside Oracle without prior written consent of Oracle. This document is not part of your license agreement, nor can it be incorporated into any contractual agreement with Oracle or its subsidiaries or affiliates.

This document is for informational purposes only and is intended solely to assist you in planning for the implementation and upgrade of the product features described. It is not a commitment to deliver any material, code, or functionality, and should not be relied upon in making purchasing decisions. The development, release, timing, and pricing of any features or functionality described in this document remains at the sole discretion of Oracle. Due to the nature of the product architecture, it may not be possible to safely include all features described in this document without risking significant destabilization of the code.

Table of contents

Purpose	6
Introduction	6
Oracle ZFS Storage Architecture	7
Key Architectural Components of On-Premises Oracle ZFS Storage Appliance	7
Key Architectural Components of Oracle ZFS Storage - HA in OCI Marketplace	8
Architectural Highlights of Oracle ZFS Storage	10
Unified Storage Architecture	10
Hybrid Storage Pool	10
Increased Virtual Memory Address Space	12
Oracle Intelligent Storage Protocol	12
Oracle ZFS Storage and Engineered Systems	13
Oracle Hybrid Columnar Compression and Automatic Data Optimization	13
Transparent Data Encryption	14
Direct NFS	14
Integrated Data Protection and Security by Design	15
Efficient Handling of Large number of Small Files in a Single Directory	15
Comprehensive Storage Analytics	16
Oracle ZFS Storage On-premises and OCI Integration	16
Comprehensive Storage Management	17
Oracle ZFS Storage Capabilities and Benefits for Oracle Private and Public Clouds	18
Extreme Performance	18
Highly Scalable and Flexible Storage Solution	18
Robust Data Protection	18
Cost Optimizations	18
Simplified Data Management	18
High Availability and Business Continuity	19
Compliance Ready	19
Hybrid Cloud Enablement	19
Integration With Third-Party Systems	19
Best of Breed Solution for Oracle Private and Public Clouds	19
Key Oracle ZFS Storage Features	19
Snapshot and Clone	19
Backup and Restore	20
Data Security and Compliance	21
Integration and Cloud Connectivity	23

Automation and Customization	24
Performance and Observability	24
Enhancements and Usability	24
Use Cases	25
Data Management and Protection	25
Unified Storage for Mixed Workloads	25
Backup & Disaster Recovery and Data Migration	26
Cloning Test/Dev Environments	27
Data Archiving and Retention Management	28
3rd Party Integration	28
Engineered Systems Storage	28
Storage for Oracle Compute Cloud@Customer	29
Database and Business Intelligence	32
Oracle Database, Data Warehouse and Business Intelligence	32
In-memory Databases	32
HPC, AI/ML and Analytics	32
Electronic Design Automation	33
SAP Shared File System	33
Media Workflow Management	34
Virtualization and Cloud Solutions	35
Secondary Storage for Oracle VMware Solution	35
Distributed Cloud Storage	35
Virtual Machine Storage	35
Network Attached Storage and Storage Area Network	36
Virtual Desktop Infrastructure	36
Conclusion	37

List of figures

Figure 1. Oracle ZFS Storage Appliance On-premises and Oracle ZFS Storage – High Availability in OCI Marketplace	6
Figure 2. Oracle ZFS Storage across on-premises and OCI	8
Figure 3. Oracle ZFS Storage Hybrid Pool Architecture	11
Figure 4. Re-ARC: ARC deduplication and parallelism	11
Figure 5. Oracle Intelligent Storage Protocol	12
Figure 6. Oracle Database Storage with Hybrid Columnar Compression	13
Figure 7. Direct NFS	14
Figure 8. DTrace Analytics	16
Figure 9. Oracle ZFS Storage on-premises and OCI Integration	17
Figure 10. Data Protection	21
Figure 11. Retention at 3 Levels	23
Figure 12. Storage Types are like Parking Options	25
Figure 13. Oracle Cloud@Customer with Embedded Oracle ZFS Storage	29
Figure 14. Oracle Exadata X9M and Oracle ZFS Storage Appliance ZS9-2 100Gb backup solution overview	30
Figure 15. Oracle Database backup/restore maximum throughput rates for ZS9	30
Figure 16. Data Protection for Oracle Exadata with Oracle ZDLRA and Oracle ZFS Appliance	31
Figure 17. SPEC Storage Performance Benchmark	33

List of tables

Table 1. Oracle ZFS Storage ZS9-2 come in two flavors.	7
Table 2. Key Architectural Components of Oracle ZFS Storage Appliance	7
Table 3. Oracle ZFS Storage – HA in OCI is available as production and test images along with the production deployment tool	8
Table 4. Key Architectural Components of Oracle ZFS Storage – HA in OCI	9

Purpose

This white paper examines the architectural capabilities, customer benefits, and use cases of Oracle ZFS Storage, making it the best-in-class enterprise storage solution for Oracle private and public cloud environments.

Introduction

Figure 1. Oracle ZFS Storage Appliance On-premises and Oracle ZFS Storage – High Availability in OCI Marketplace

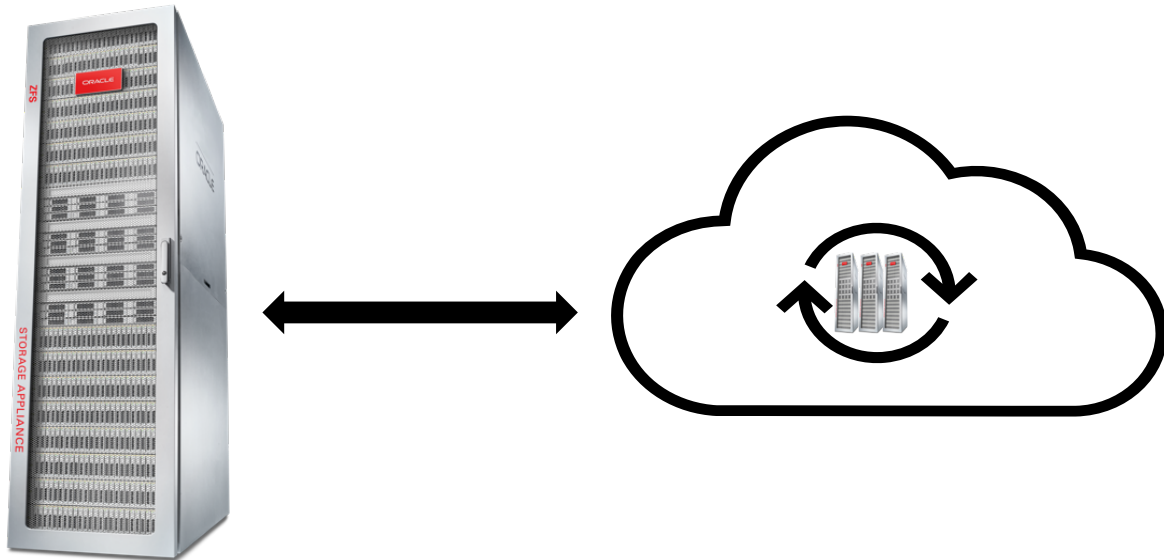

Enterprises are increasingly adopting both private and public cloud environments to meet their workload requirements, and storage is a critical component of this equation. Enterprises need a storage solution that is scalable, reliable, secure, high-performance, and cost-effective, and that can support a wide variety of workloads.

Oracle ZFS Storage is a powerful and feature-rich storage solution that meets all these requirements. It is available as both an on-premises appliance and an Oracle Cloud Infrastructure (OCI) marketplace image. Oracle ZFS Storage is a unified storage solution that provides file, block, and object storage capabilities. It is architected with hybrid storage pool technology and has security built in from the ground up. It is also highly optimized for Oracle Databases and other Oracle engineered systems.

Oracle ZFS Storage is the best-of-breed storage solution for Oracle databases and workloads. It is specifically co-engineered with other Oracle platforms, which means that the hardware and software of both products have been designed and tested together to ensure optimal performance, reliability, and manageability. Oracle owns both the database and the storage platforms, which allows it to make optimizations on both sides to deliver extreme performance. The goal is for Oracle ZFS Storage to take full advantage of the features and capabilities of Oracle databases.

Oracle ZFS Storage Appliance is a critical element of some of the Oracle engineered systems, and it can be used as production storage for Oracle Private Cloud Appliance and Compute Cloud@Customer as it is an integral part of these platforms. It can also be used as a cost-effective and high performance backup solution for Oracle Exadata.

In addition, Oracle ZFS Storage – High Availability (HA) is available on the OCI Marketplace as an image that can be installed on a compute instance to provide storage in OCI. This makes it a good option for customers who want to balance workloads across on-premises and OCI environments, or who want to take advantage of the scalability and flexibility of the cloud without sacrificing performance or reliability, or for those who wish to have backup and/or disaster recovery environments in OCI.

Oracle ZFS Storage Architecture

Key Architectural Components of On-Premises Oracle ZFS Storage Appliance

The latest Oracle ZFS Storage Appliance Racked System ZS9-2 is a 42RU chassis that houses two powerful 2RU x86 controllers. These controllers power the storage subsystem, which can be built with hard disk drives (HDDs) for capacity or solid-state drives (SSDs) for performance. The Oracle ZS9-2 is the 7th generation of Oracle ZFS Storage Appliance (ZFSSA) and inherits the versatile architecture and capabilities of its predecessors. Since its introduction in 2008, Oracle ZFSSA has continuously evolved with value-adding features. It is battle-tested in numerous customer environments across the globe.

Table 1. Oracle ZFS Storage ZS9-2 come in two flavors.

ZFS STORAGE APPLIANCE ZS9-2 RACKED SYSTEM	Configuration
High End (HE)	<ul style="list-style-type: none"> Unified storage system for demanding workloads at attractive price point Supports a maximum of 48 storage enclosures or disk trays Up to 25PB of raw storage per ZFSSA Max drives: 1152; 128 CPU cores, 4TB DRAM
Mid-Range (MR)	<ul style="list-style-type: none"> Unified storage system for workloads demanding extreme performance and scalability at price points that rival competitive mid-range and high-end systems Supports a maximum of 24 storage enclosures or disk trays Up to 13PB of raw storage per ZFSSA Max Drives: 576, 96 CPU cores, 2TB DRAM

Oracle ZFSSA is a high-performance converged storage solution designed for maximum performance, robust data protection, and simplified management. It leverages standard enterprise hardware and is powered by the 64-bit Oracle Solaris Operating System (OS) based on Symmetric Multiprocessing Architecture (SMP).

Oracle ZFSSA's 64-bit architecture enhances virtual memory address space, stability, and scalability for workloads. The appliance excels in virtualization environments, booting thousands of virtual machines and containers in high-burst random I/O scenarios.

Oracle ZFSSA incorporates advanced capabilities for data protection, check summing, data services, and automatic data tiering while consistently delivering exceptional throughput and transactional performance. Its unique hybrid storage pool architecture combines caching and auto-tiering to optimize transactional workloads effectively and cost-efficiently. Oracle ZFS File System efficiently manages client traffic, isolating it from latency penalties associated with spinning disks.

Table 2. Key Architectural Components of Oracle ZFS Storage Appliance

COMPONENT	Functions
CONTROLLER	<ul style="list-style-type: none"> Built with powerful x86 processors for efficient data storage, protection, and performance Configurable as a single controller or dual controller system for high availability Supports Ethernet and Fiber Channel for front end traffic

	<ul style="list-style-type: none"> Handles computations required for data protection, data reduction, data services, and caching
STORAGE ENCLOSURE	<ul style="list-style-type: none"> Holds SAS based HDDs or SSDs Can be configured with all SSDs, all HDDs, or a combination of SSDs and HDDs Supports high-endurance SSDs for read and/or write acceleration
SOFTWARE	<ul style="list-style-type: none"> Oracle ZFSSA OS is a storage-optimized OS that uses Oracle Solaris kernel and Oracle ZFS File System Provides enterprise-class data services, including robust data protection, data reduction, and data management Employs Hybrid Storage Pool technology to manage dynamic caching and optimize data access and storage performance Provides fine-grain analytics through Dtrace, a technology available in Oracle Solaris OS Offers comprehensive visibility of key metrics through command-line interface (CLI) or browser user interface (BUI)

Key Architectural Components of Oracle ZFS Storage - HA in OCI Marketplace

Figure 2. Oracle ZFS Storage across on-premises and OCI

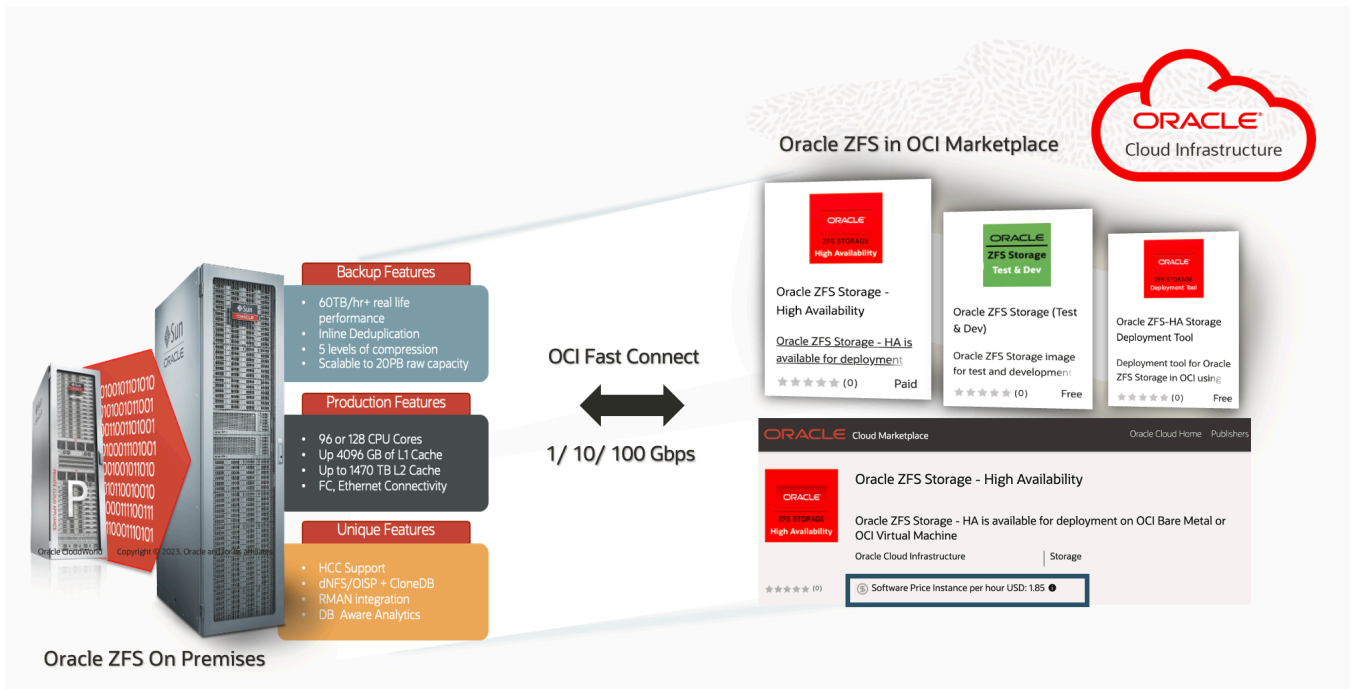

Oracle ZFS - HA in OCI marketplace leverages the highly scalable high-availability OCI architecture to enable numerous distributed cloud use cases for a variety of workloads.

Table 3. Oracle ZFS Storage – HA in OCI is available as production and test images along with the production deployment tool

ZFS STORAGE IN OCI	Configuration
--------------------	---------------

Oracle ZFS -HA Controller Image	<ul style="list-style-type: none"> • Paid offer in OCI Marketplace • Can be configured as a single controller or dual controller system (Active/Active or Active/Passive clustering) for high availability, similar to on-premises Oracle ZFSSA. • Can be provisioned as a Virtual Machine or Bare Metal instance using a Terraform stack in OCI • Up to 1PB of automated capacity scaling for Oracle ZFS - HA in OCI
Oracle ZFS Storage – Test & Dev	<ul style="list-style-type: none"> • Free, limited-resource Oracle ZFS image available in OCI Marketplace for testing Oracle ZFS HA in OCI
Oracle ZFS - HA Storage Deployment Tool	<ul style="list-style-type: none"> • Free Terraform stack to automate Oracle ZFS - HA cluster deployment • It configures the compute instances, VNICs, and IP addressing needed to build a full Oracle ZFS - HA cluster.

Oracle Cloud Infrastructure (OCI) offers several key Oracle ZFSSA on-premises features, as both systems use the same codebase albeit with different release cadence. OCI ZFS instances can be spawned in two flavors: virtual machines (VMs) and bare metal (BM). A Terraform stack provisions the nodes and creates a cluster. This is the only difference between Oracle ZFS Storage on-premises and in OCI. Otherwise, the way you interact with ZFS in OCI is the same. The key components of Oracle ZFS – HA in OCI are as follows:

Table 4. Key Architectural Components of Oracle ZFS Storage – HA in OCI

COMPONENT	Description
OCI Infrastructure Components	<ul style="list-style-type: none"> • Compute: Bare metal and virtual machine compute instances • Storage: Leverages OCI Block Volume (BV) for spawning files and LUNs, and OCI Object Storage. BVs are encrypted and redundant at the OCI level, so drive failure doesn't affect the volume. • Networking: Virtual Cloud Network (VCN), load balancer, VPN Connect, FastConnect • Built-in redundancy: Across OCI fault domains and replication across instances in different regions for further data redundancy.
ZFS Software in OCI	<ul style="list-style-type: none"> • Oracle ZFS - HA, Oracle ZFS Storage – Test & Dev and Oracle ZFS - HA Storage Deployment Tool • Supports all the key storage protocols, data services and management capabilities offered by on-premises appliance <ul style="list-style-type: none"> • Protocols: <ul style="list-style-type: none"> • NFS v2, v3, v4 • SMB v1, v2, v3 • OISP (dNFS) • OCI, S3 object storage • HTTP / HTTPS • WebDAV • FTP, SFTP, FTPS • NDMP (2- and 3-Way) • Data Services: <ul style="list-style-type: none"> • Snapshots/clones, • Quotas & reservations, • Compression (5levels plus HCC), • Share, LUN, project, pool-wise encryption, • Backup to OCI object Storage • Antivirus via ICAP protocol • HA Clustering • Management <ul style="list-style-type: none"> • App and Cloud-aware Analytics

	<ul style="list-style-type: none"> • Browser, CLI, and REST interfaces • Management dashboard • Component view • Role-based access control • Snapshot and Object retention policies • Event and threshold-based alerting • Scripting • Workflow automation • ZFS-HA Deployment Tool
ZFS in OCI Integration	<ul style="list-style-type: none"> • Seamless with on-premises Oracle ZFSSA as well as with other OCI services, including compute instances and identity management (Active Directory, LDAP) for enhanced data management and security

Architectural Highlights of Oracle ZFS Storage

Oracle ZFS Storage architecture is a well-designed blend of hardware, software, and infrastructure features and capabilities that optimizes performance, efficiency, and manageability in both on-premises and OCI cloud environments. It offers a wide range of functionalities that make it a great fit for diverse use cases in Oracle private or public cloud environments.

Oracle maintains consistency in architectural features and capabilities across on-premises and cloud deployments via its common code base, ensuring a uniform, high-quality experience for customers regardless of their deployment choice. This architectural consistency also simplifies the transition for enterprises migrating to the cloud.

Unified Storage Architecture

Oracle ZFS Storage features a unified storage architecture that enables enterprises to consolidate their storage infrastructure and meet diverse workload requirements cost-effectively. Supporting multiple storage protocols such as Network File System (NFS), Server Message Block (SMB), Internet Small Computer Systems Interface (iSCSI), etc., and providing file, block, and object storage capabilities within a single system, ZFS Storage simplifies management and enhances flexibility, eliminating the need for separate storage systems and reducing complexity. This streamlines storage management processes and facilitates seamless integration with existing IT environments, allowing enterprises to incorporate Oracle ZFS Storage without significant disruptions or modifications. This compatibility ensures smooth data migration and transition, promoting operational continuity. Additionally, the unified storage architecture provides a consolidated view of storage resources, simplifying provisioning, management, and administration. With a centralized view, administrators can easily allocate and manage storage capacity, apply consistent management policies, and improve overall operational efficiency.

Furthermore, the unified storage architecture improves resource utilization and cost-effectiveness. By consolidating storage resources, enterprises can eliminate storage silos, optimize capacity utilization, and reduce capital and operational expenditures. Additionally, the unified storage architecture contributes to lower power and cooling costs, resulting in enhanced cost savings.

Hybrid Storage Pool

Oracle ZFS Storage hybrid storage pool architecture is a carefully designed approach that maximizes performance and data management by leveraging key components and intelligent algorithms.

Figure 3. Oracle ZFS Storage Hybrid Pool Architecture

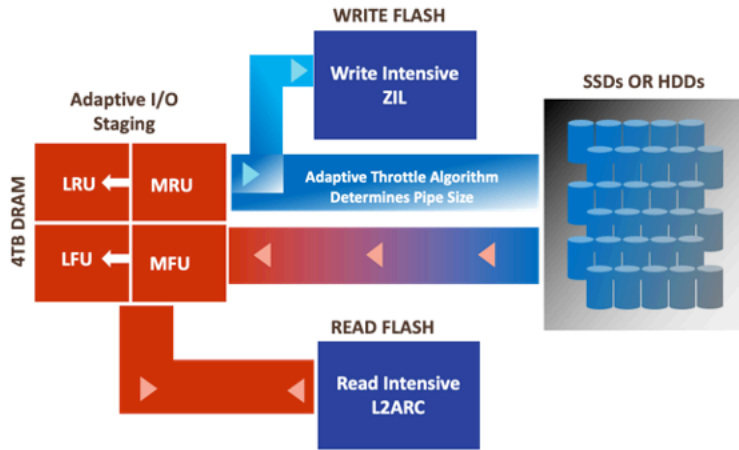

At the heart of this architecture is a dynamic random-access memory (DRAM) based cache known as the Adaptive Replacement Cache (ARC). By utilizing the Most Recently Used (MRU) and Most Frequently Used (MFU) algorithms, the ARC optimizes read performance by keeping hot data in system memory.

To further enhance performance, the Level 2 Adaptive Replacement Cache (L2ARC) extends caching to solid-state drives (SSDs). Acting as a secondary cache layer, the L2ARC holds less frequently accessed but valuable data, using the same MFU and MRU algorithms found in the ARC.

For synchronous write operations and data consistency, the ZFS Intent Log (ZIL) plays a crucial role. It employs a Log-Structured Write (LSW) algorithm, ensuring data integrity even in the event of power loss or system failure.

To intelligently manage data placement in the cache tiers, the Oracle ZFS hybrid storage pool architecture employs advanced caching algorithms, including Least Recently Used (LRU), Least Frequently Used (LFU), and other adaptive algorithms. These algorithms dynamically analyze data access patterns to optimize caching, improving overall performance and reducing latency.

Re-ARC is a new enhancement implemented in the hybrid storage pool architecture which enables in-memory deduplication capabilities, resulting in significant reduction in consumption of ARC by 400%. By identifying and eliminating redundant data, Re-ARC optimizes the caching mechanism, boosts performance, and enables the appliance to handle larger workloads with reduced memory requirements.

Figure 4. Re-ARC: ARC deduplication and parallelism

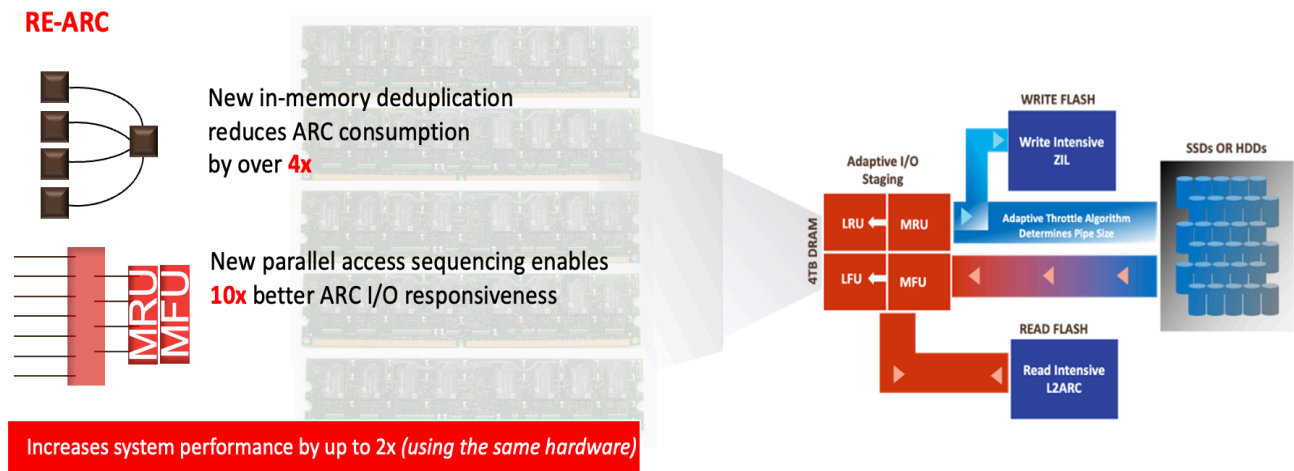

Increased Virtual Memory Address Space

Oracle ZFS Storage is powered by the Oracle Solaris OS which leverages Intel x86 multicore CPUs. By utilizing a 64-bit architecture, the appliance can handle larger memory spaces, provide better stability under heavy workloads and offering flexibility for future scalability. It can easily scale both virtual machine (VM) and container workloads while providing efficient resource allocation, dynamic provisioning and streamlined management allowing enterprises to allocate storage resources to VMs and containers as needed. Its data reduction features like compression and duplication, and efficient data placement, maximize storage utilization and enable efficient scaling of workloads.

Oracle Intelligent Storage Protocol

Oracle Intelligent Storage Protocol (OISP) is a unique feature of Oracle ZFS Storage that enables direct communication between storage system and Oracle database. By eliminating unnecessary layers of abstraction, OISP significantly reduces latency and improves I/O performance. This protocol intelligently offloads data intensive operations to the storage appliance, resulting in faster response time and enhanced overall performance for Oracle workloads.

Figure 5. Oracle Intelligent Storage Protocol

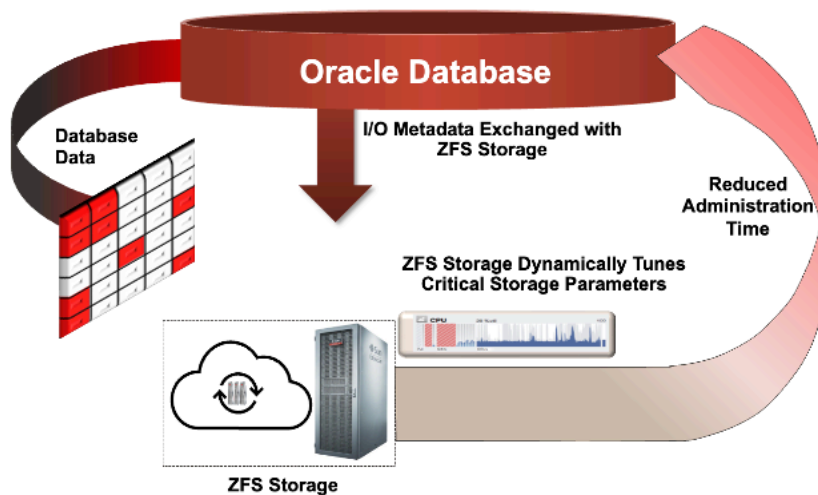

With OISP, Oracle databases, starting from Release 12c and later versions, can send dynamic hints to Oracle ZFS Storage. These hints provide information about the type of workload running on the database server and the nature and priority of that workload.

Oracle ZFS Storage utilizes these hints to make dynamic decisions for optimizing record size of database files and logbias settings of the shares. In Oracle ZFS Storage, the "logbias" setting determines how synchronous write operations are handled in the Oracle ZFS File System. It specifies the behavior for writing metadata and small synchronous writes, influencing where these writes are directed and how they are prioritized. The logbias setting can have the following values:

- **Latency:** This setting prioritizes low-latency synchronous writes, directing them to the ZFS Intent Log (ZIL) on the fastest storage tier (such as SSDs). It aims to optimize performance by minimizing the latency of critical write operations.
- **Throughput:** This setting prioritizes throughput for synchronous writes. It directs the writes to the main storage pool, rather than the ZIL, which can improve overall write performance for large sequential writes.

This intelligent protocol allows Oracle ZFS Storage to allocate dedicated resources and threads to critical database operations, ensuring consistent performance and preventing resource contention.

Additionally, OISP enables negative cache hints to be passed with large block streaming workloads. This allows Oracle ZFS Storage to evict non-critical blocks from DRAM, freeing up resources for more essential database blocks.

OISP also enhances analytics by providing detailed information with each I/O operation, which can be displayed through various charts on the BUI (Browser User Interface). This granular view of database operations enables effective troubleshooting and analysis, especially in complex multitenant database environments.

Oracle ZFS Storage and Engineered Systems

Oracle ZFS Storage is an integral part of several key Oracle Engineered Systems, as well as a highly efficient external storage solution that supports these platforms. Oracle Engineered Systems are integrated, full-stack platforms that are developed and tested together with Oracle Database and applications to run mission-critical customer workloads faster, at lower costs, and with greater security than multi-vendor, on-premises solutions.

Because Oracle ZFS Storage is co-engineered with Oracle Engineered Systems, databases, and software stacks, the overall solution provides a highly optimized, best-of-breed offering that integrates Oracle advanced technologies for database workloads, such as OISP, Hybrid Columnar Compression (HCC), Transparent Database Encryption (TDE), Automatic Data Optimization (ADO), and Direct NFS. This results in tremendous storage efficiencies, performance boosts, and scalability for all types of workloads.

Oracle Hybrid Columnar Compression and Automatic Data Optimization

Figure 6. Oracle Database Storage with Hybrid Columnar Compression

- 10X to 50X data reduction for query and historic data
- Up to 8X query acceleration
- Works with encryption
- Policy-driven incremental HCC levels with Automatic Data Optimization
- Maintain efficiency advantage in analytics, development and testing

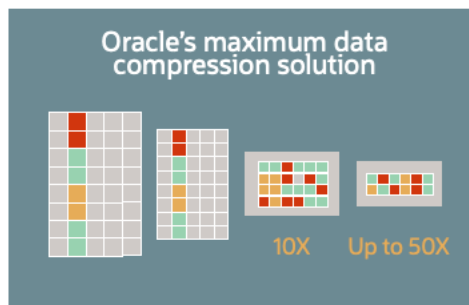

Oracle ZFS Storage features two innovative technologies that can help enterprises to significantly reduce their storage costs and improve their database performance: Hybrid Columnar Compression (HCC) and Automatic Data Optimization (ADO).

HCC is a feature of Oracle Database that works in conjunction with Oracle ZFS Storage to achieve high compression ratios and improve query performance.

It works by compressing data at the column level. This is different from traditional compression methods, which compress data at the row level. Columnar compression is more efficient because it avoids compressing redundant data. HCC also takes advantage of the unique features of Oracle ZFS Storage. For example, HCC uses Oracle ZFS Storage check summing capabilities to ensure that compressed data is not corrupted. HCC also uses Oracle ZFS Storage tiering capabilities to automatically move compressed data to less expensive tiers of storage. As a result of these features, HCC can achieve compression ratios of 10x to 50x for Oracle Database workloads, such as data warehousing, analytics, and archiving. HCC can also accelerate query performance by 3x to 8x.

ADO automates the process of compressing and tiering data at the row or segment level based on usage patterns and administrator-defined policies. It uses Heat Map data to identify data that is rarely accessed or that can be compressed. This data can then be moved to a lower-cost tier of storage, such as cold storage, or compressed to reduce its size. ADO policies can be created at the table, partition, or index level. These policies can be used to specify

when and how data is compressed and moved, as well as to specify different tiers of storage for different types of data.

When used with Oracle ZFS Storage, ADO can take advantage of HCC technology to further enhance compression ratios and storage efficiency. ADO can also leverage the tiering capabilities of Oracle ZFS Storage to automatically move data between different tiers of storage within the ZFSSA, based on the policies defined in Oracle Database.

Suppose you have a table that contains historical sales data. You want to keep this data for archival purposes, but you don't need to access it very often. You can use HCC and ADO to compress and move the historical sales data to a lower-cost tier of storage, such as cold storage.

To do this, you would first create an ADO policy for the table. The policy would specify that the data should be compressed and moved to cold storage if it has not been accessed in the past 90 days. Once you have created the policy, ADO will monitor the table and automatically compress and move the data to cold storage according to the policy. When you need to access the historical sales data, ADO will automatically decompress and move the data back to a high-performance tier of storage so that you can access it quickly.

HCC and ADO are powerful tools that can help you to improve the performance, storage efficiency, and cost of your Oracle databases for data warehousing, analytics, and archiving. They are especially well-suited for databases that contain large amounts of historical data or other data that is rarely accessed.

Transparent Data Encryption

Transparent Data Encryption (TDE) is a feature of Oracle Database Advanced Security that encrypts data at rest. This means that the data is encrypted when it is stored on disk, and it is decrypted when it is accessed by an application. TDE can help to protect data from unauthorized access, even if the attacker has physical access to the server.

Oracle ZFS Storage is designed to be compatible with TDE whether it is used for database primary storage or backup. The close design of Oracle ZFS Storage and database software through OISP ensures that Oracle ZFS Storage provides both performance and security.

Direct NFS

Direct NFS (dNFS) is a feature that allows Oracle ZFS Storage to provide high performance NFS access to clients. It is a feature within Oracle Database that allows for direct access to NFS storage, bypassing the traditional kernel based NFS server running on client's operating system. It improves performance by leveraging parallelism and load balancing across multiple NFS servers.

Figure 7. Direct NFS

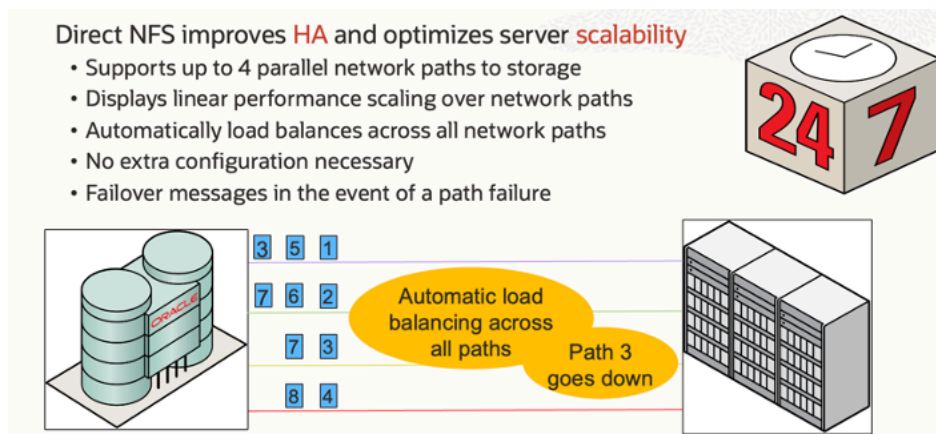

Further, dNFS simplifies storage management and administration by providing transparent integration with NFS storage without requiring additional configuration or administrative overhead. It simplifies tasks such as provisioning

storage, configuring access controls, and managing filesystems, making storage administration more efficient and user friendly, thereby reducing administrative complexity.

Integrated Data Protection and Security by Design

Oracle ZFS Storage is specifically engineered to provide integrated data protection and security across both on-premises and cloud-based solutions. Oracle ZFS Storage prioritizes comprehensive data protection and security, ensuring the integrity, reliability, and confidentiality of stored data across on-premises storage appliances and cloud-based solutions.

A cornerstone of Oracle ZFS Storage's data protection strategy is the implementation of multiple RAID protection levels, including mirror, RAIDZ1, RAIDZ2, and RAIDZ3. These configurations offer varying degrees of data redundancy, effectively safeguarding against disk failures and maintaining continuous data availability. To uphold data integrity, the system employs Merkle Hash Tree throughout the data path, utilizing checksums to protect against bit rot, data corruption, and various errors. Regularly scheduled pool scrubbing further enhances data integrity by verifying and rectifying potential inconsistencies.

Oracle ZFS Storage safeguards data security through a comprehensive approach that encompasses RBAC and end-to-end integrity measures. Role-Based Access Control (RBAC) enforces granular control over access privileges, ensuring that only authorized users have the necessary permissions to access sensitive data. This RBAC-based access control strategy provides an extra layer of protection against unauthorized access and potential security threats. Complementing RBAC, Oracle ZFS Storage employs end-to-end integrity measures to protect data from corruption or tampering. Each data block is verified against an independent checksum stored in its parent block pointer, effectively isolating data from checksum errors. The ZFS File System operates as a self-validating Merkle tree of blocks, providing robust authentication and ensuring tamper-proof data protection. Furthermore, Oracle ZFS Storage's capabilities extend to ransomware recovery, leveraging immutable snapshots that resist alterations, encryption, or deletion by ransomware attacks. In summary, Oracle ZFS Storage's security features, including RBAC and end-to-end integrity measures, provide a robust foundation for protecting sensitive data from unauthorized access, corruption, and ransomware attacks.

Oracle ZFS Storage seamlessly facilitates data archival across diverse storage media, spanning on-premises deployments and Oracle ZFS Storage in OCI. This archival process involves storing data for extended periods, often for compliance or historical purposes, aligning closely with retention management. Data integrity is preserved until the expiration of the defined retention period. Oracle ZFS Storage offers retention policies at the snapshot, file, and object levels, encompassing immutable snapshots, data encryption, audit logging, file retention, and raw crypto replication. These features underscore its commitment to comprehensive data protection and archival practices across various storage media. The integration extends to OCI object store, tapes (via Oracle StorageTek Virtual Storage Manager or VSM), and cloud destinations like AWS S3 buckets, providing organizations with versatile and secure archival solutions.

Efficient Handling of Large number of Small Files in a Single Directory

Oracle ZFS Storage is exceptionally efficient at managing a large number of small files due to its optimized design and feature set. It employs a dynamic block allocation system and variable block sizes, minimizing metadata overhead associated with small files. The Copy-On-Write (CoW) file system ensures that only modified data is written, avoiding unnecessary rewrites. Additionally, features like deduplication and compression reduce the storage footprint of small files. For example, in a scenario where a file system contains millions of small text documents, Oracle ZFS would efficiently store and manage the metadata and content of each file, maximizing storage utilization and minimizing performance overhead. Its ability to parallelize operations and employ efficient caching mechanisms further enhances its capability to handle a large volume of small files with speed and efficiency.

Comprehensive Storage Analytics

Oracle ZFS Storage Analytics is a powerful tool that uses DTrace – a Solaris’ operating system utility, to provide comprehensive insights into customer’s storage environment. It helps customers manage, monitor, and troubleshoot Oracle ZFS Storage systems more efficiently.

Oracle ZFS Storage Analytics leverages DTrace’s dynamic tracing capabilities to access kernel-level data, providing real-time visibility into customers’ storage environment, including hardware, firmware, OS, and VM level details.

A unique feature of Oracle ZFS Storage Analytics is its ability to drill down from high-level system metrics to individual events. This allows administrators to investigate potential issues with great precision, making it easier to diagnose and resolve problems.

Figure 8. DTrace Analytics

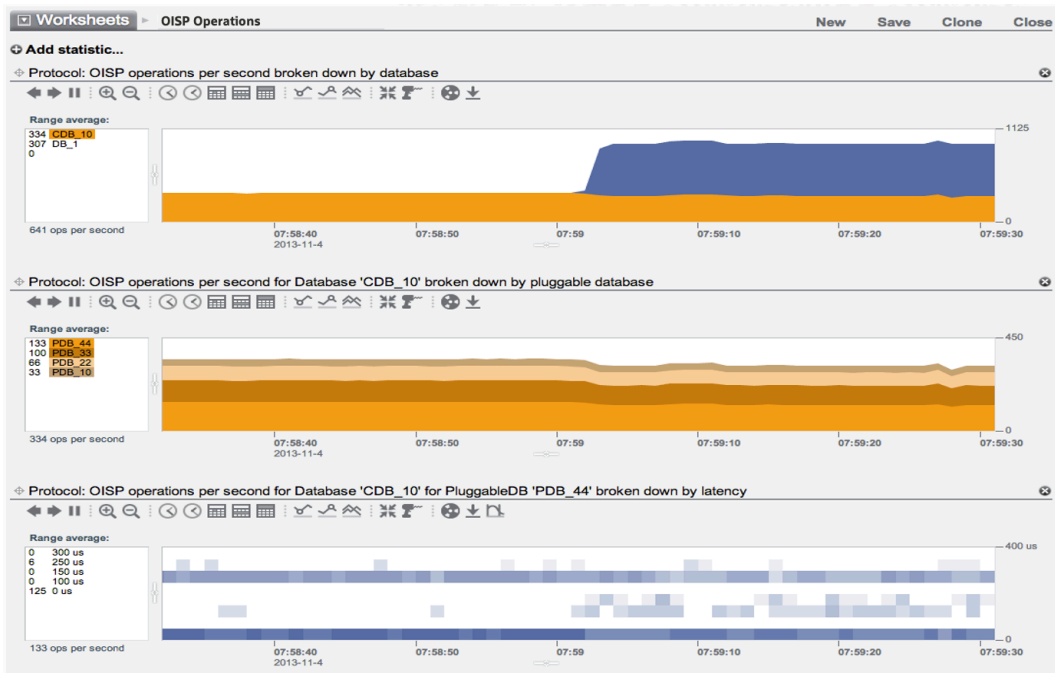

Oracle ZFS Storage Analytics is also available on OCI, where it can be used to monitor and manage the performance of block volumes. This can help users size VMs and optimize deployments. For example, customers can use it to determine if they are using the right shape, or if they are CPU or block volume constrained. This information can help them optimize their deployment and ensure that they are getting the most out of their ZFS storage environment.

Oracle ZFS Storage Analytics can also be integrated with Oracle Enterprise Manager (OEM) to provide a unified view of the entire IT infrastructure, including Oracle ZFS storage systems. This integration provides administrators with a single pane of glass for monitoring and managing all their IT resources.

Oracle ZFS Storage On-premises and OCI Integration

Oracle ZFS seamlessly integrates from on-premises to Oracle Cloud Infrastructure (OCI), delivering a unified storage experience across environments with the option of leveraging the fast connectivity option – Oracle FastConnect. Leveraging the same codebase, Oracle ZFS Storage instances in OCI offer identical features as their on-premises counterparts. Provisioning in OCI involves flexible options, allowing customers to deploy as virtual machines (VMs) or bare metal (BM) servers through a Terraform stack. This streamlined process ensures a smooth transition to the cloud.

Figure 9. Oracle ZFS Storage on-premises and OCI Integration

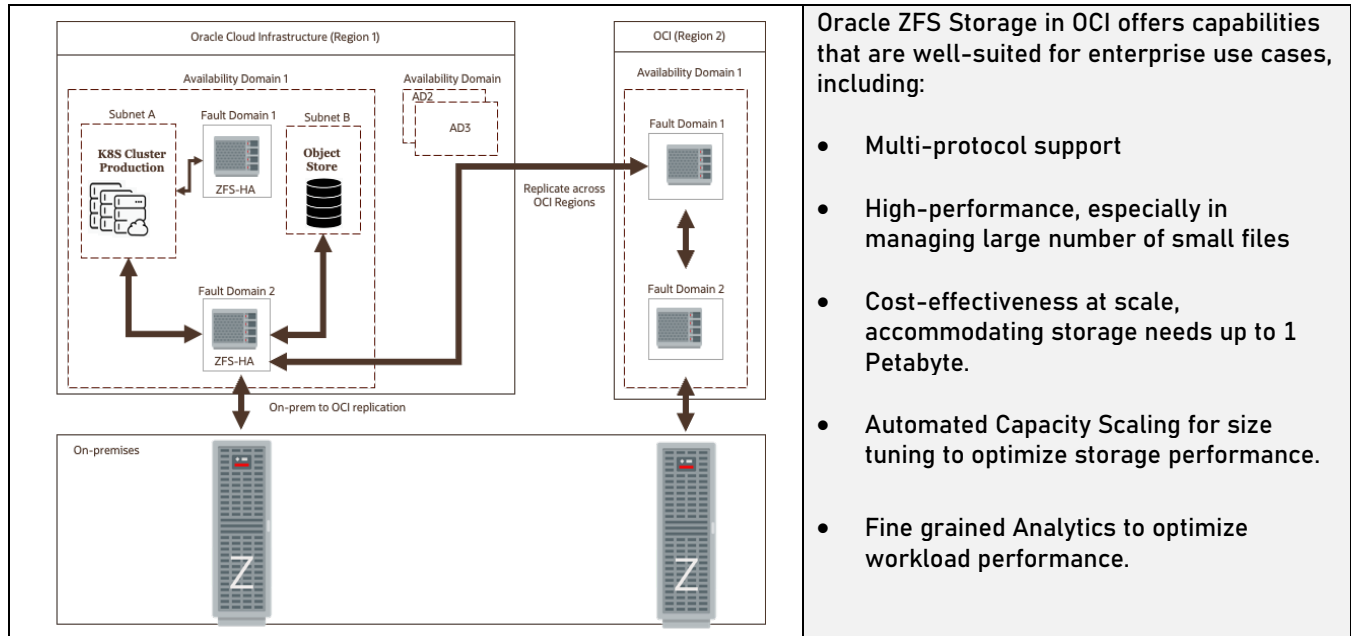

Oracle ZFS Storage in OCI offers capabilities that are well-suited for enterprise use cases, including:

- Multi-protocol support
- High-performance, especially in managing large number of small files
- Cost-effectiveness at scale, accommodating storage needs up to 1 Petabyte.
- Automated Capacity Scaling for size tuning to optimize storage performance.
- Fine grained Analytics to optimize workload performance.

Customers have the flexibility to deploy Oracle ZFS Storage in OCI in either standalone storage controller mode or high-availability (HA) mode, providing options for active-active or active-passive configurations. The redundancy built at the block level, combined with the ability to configure a striped pool, ensures high reliability and performance. Oracle ZFS Storage in OCI supports hybrid replication for disaster recovery, along with archiving to object storage, offering both standard and archival storage options. As storage needs scale into multi-terabyte sizes, it proves to be economical, providing cost-effective solutions. The system excels in handling a large number of small files in a single directory, supporting multi-protocol environments, and automatically scaling capacity to grow storage pools while allowing users to set limits to avoid billing surprises. With Oracle Enterprise Manager (OEM) integration, customers benefit from full-stack observability, ensuring efficient administration and management of their storage infrastructure.

Comprehensive Storage Management

Oracle ZFS Storage offers comprehensive management capabilities that enable effective and efficient utilization of storage resources. It offers a variety of flexible management methods, accommodating different administrative needs, whether in traditional datacenter environment or modern distributed cloud architectures, highlighting its suitability and strength as a storage solution in both private and distributed cloud environments.

- **Browser User Interface (BUI)** is an intuitive web-based interface that provides easy access to Oracle ZFS Storage's diverse features. Administrators can perform routine management tasks, monitor system health, and troubleshoot issues, all from a unified platform.
- **Command Line Interface** is for administrators who prefer script-based management, Oracle ZFS Storage provides a powerful CLI. This tool allows administrators to automate tasks and integrate ZFS Storage management with other system management scripts, increasing operational efficiency.
- **Restful APIs** provide programmatic access to Oracle ZFS Storage features, allowing for integration with custom applications and automated workflows. They cater to the requirements of distributed cloud environments, where remote and automated management is often required.
- **Oracle Enterprise Manager** integrates seamlessly with the Oracle ZFS Storage, allowing centralized management of Oracle technologies. It enables administrators to monitor and manage their Oracle ZFS Storage along with other Oracle technologies from a single console.

- **Oracle Enterprise Manager Cloud Control** provides a pre-installed OEM environment on an OCI VM for managing both cloud and on-prem environments. It allows administrators to manage their Oracle ZFS Storage resources in the cloud along with their on-premises resources, providing a unified management platform for distributed cloud environments.

Oracle ZFS Storage Capabilities and Benefits for Oracle Private and Public Clouds

Oracle ZFS Storage offers a numbers of customer benefits which empower enterprises to efficiently manage their data, ensure data protection and availability, optimize costs, and seamlessly integrate their storage infrastructure across on-premises and cloud environments.

Extreme Performance

Oracle ZFS Storage empowers businesses to optimize their storage needs and achieve cost savings through its advanced features and high-performance architecture.

- **Enhanced performance:** High-performance HSP architecture and advanced caching mechanisms deliver exceptional performance for both read and write workloads.
- **Reduced storage costs:** Advanced compression, deduplication technologies including HCC and dNFS features optimized for Oracle database significantly reduce storage requirements, lowering storage costs.
- **Enhanced storage utilization:** Thin provisioning and COW, the underlying technology for snapshots, clones, and replications, optimize storage utilization and eliminate waste.

Highly Scalable and Flexible Storage Solution

Oracle ZFS Storage adapts to customers evolving data demands with unparalleled scalability, supporting up to 25PB of raw storage on Oracle ZFSSA and 1PB in the OCI Marketplace. Its flexible deployment options cater to diverse needs, allowing customers to choose between on-premises, cloud, or hybrid environments.

Robust Data Protection

Oracle ZFS Storage is a comprehensive data storage platform that provides customers with a wide range of data protection features, including encryption, role-based access control, RAID, check summing, snapshots, replication, audit, logging and retention locks. These features help businesses protect their data from accidental loss to major disaster, maintain customer trust, and improve profitability.

Cost Optimizations

Oracle ZFS Storage empowers customers to achieve optimal cost and storage management through its advanced storage features and automatic capacity expansion in cloud deployments. By leveraging data compression, deduplication, COW, and thin provisioning technologies, Oracle ZFS Storage significantly reduces storage requirements and optimizes storage utilization, leading to lower storage costs. Additionally, its seamless automatic capacity expansion in cloud environments ensures that businesses always have the storage they need without the need for manual provisioning, further streamlining storage management and enhancing cost efficiency.

Simplified Data Management

Oracle ZFS storage simplifies data management, empowering businesses to make informed decisions, boost efficiency, reduce costs, and enhance customer service. Its comprehensive suite of features and tools, including app and cloud-aware analytics, intuitive interfaces, advanced management tools, robust data protection policies, proactive

alerting, automation capabilities, and seamless deployment tools, streamlines data administration and optimizes storage utilization.

High Availability and Business Continuity

Oracle ZFS Storage provides comprehensive data protection and business continuity solutions, enabling businesses to safeguard their critical data against disruptions and ensure continuous operations. Its robust features, including local and remote replication, failover clustering, and self-healing file systems, empower businesses to maintain high availability and prevent costly downtime.

Compliance Ready

Oracle ZFS Storage is a compliance-ready solution that helps enterprises meet their data governance and regulatory requirements, including FINRA, SEC, and the European Union's Commission Delegated Regulation.

Hybrid Cloud Enablement

Oracle ZFS Storage simplifies the deployment and management of hybrid cloud storage solutions, enabling customers to seamlessly extend on-premises storage to the cloud, improve performance, scalability, and cost savings, and solve workload mobility, efficient data replication, and disaster recovery challenges across Oracle private and public cloud environments.

Integration With Third-Party Systems

Oracle ZFS Storage seamlessly integrates with third-party systems, allowing customers to leverage their existing infrastructure investments. It provides interoperability with a wide range of applications, platforms, and storage solutions, enabling customers to build comprehensive storage ecosystems tailored to their specific requirements.

- **Backup Software Integration:** Veritas NetBackup, Commvault
- **Multi-protocol support** including NFS, SMB, iSCSI, HTTPS, WebDav, and FTP/FTPS/SFTP
- **Cloud Integrations:** Amazon S3, Oracle OCI and OpenStack Swift

Best of Breed Solution for Oracle Private and Public Clouds

Oracle ZFS Storage is a top-tier storage solution for Oracle databases and workloads, designed to deliver exceptional performance, reliability, and manageability. Co-engineered with other Oracle platforms, it seamlessly integrates with Oracle databases to optimize both sides and fully leverage the features of Oracle software. Ideal for Oracle-on-Oracle environments running engineered systems, Oracle software, or OCI services, it provides seamless compatibility, high performance, cutting-edge data protection, and simplified management.

Key Oracle ZFS Storage Features

Oracle ZFS Storage offers a variety of features, and the following are some of the highlights.

Snapshot and Clone

Oracle ZFS Storage includes various features related to snapshots, such as efficient snapshot creation, management, and cloning. Snapshots provide point-in-time copies of datasets, enabling data protection, data recovery, and efficient data cloning for various purposes.

- **Copy-On-Write (COW)** is a data storage technique that allows multiple processes to share the same data until it is modified. COW creates a copy of the data when it is modified and assigns the new copy to the process that

made the modification. This allows the original data to be shared with other processes that are still using it. COW is often used to implement snapshots and clones of file systems and virtual machines.

- **Point-in-Time Snapshots** capture the filesystem state at a specific moment, allowing users to revert to previous versions of files or directories, ensuring data integrity and enabling disaster recovery.
- **Space-efficient Snapshots** utilize a copy-on-write mechanism to store only modified data, resulting in efficient utilization of disk space. This enables the creation of numerous snapshots without a significant impact on storage capacity.
- **Automatic Snapshot Scheduling** allows administrators to define snapshot policies to create snapshots at specified intervals, ensuring regular and consistent snapshotting of file systems without manual intervention. This can help to improve data protection and recovery capabilities, as snapshots can be used to restore data to a previous point in time.
- **Snapshot Replication:** supports the replication and efficient transfer of snapshots to a secondary storage system, providing data protection and disaster recovery capabilities.
- **Snapshot Clones** enable writable copies of snapshots to be used as independent file systems. This feature facilitates the rapid provisioning of new environments or the creation of test/development environments from existing snapshots.
- **Snapshot Rollback** allows users to revert file systems to a previous state, discarding any changes made after the selected snapshot was taken.
- **Snapshot Send/Receive** enables the efficient transfer of snapshots between Oracle ZFS Storage systems over a network, facilitating data migration, offsite backups, and replication.
- **Snapshot Management** provides comprehensive tools for managing snapshots, including listing, browsing, and deleting snapshots. Administrators can easily track and manage snapshot usage to optimize storage utilization.
- **Space Reservation** ensures that sufficient storage capacity is allocated to accommodate future snapshots. This feature prevents snapshots from consuming all available storage space, maintaining system performance and stability.
- **Snapshot Visibility** provides a unified view of snapshots within the file system hierarchy. Users can navigate and access snapshots at different levels of the directory structure, simplifying snapshot management and access control.

Backup and Restore

Oracle ZFS Storage offers a comprehensive set of backup and restore features that provide data protection and facilitate reliable recovery. Here are the key features related to backup and restore:

- **Block-level backups** back up individual data blocks instead of entire files. This can save time and storage space, as only the changed blocks need to be backed up. Block-level backups are also more granular than file-level backups, which means that they can be used to restore individual files or folders.
- **Block-level incremental backups** only back up the blocks that have changed since the last backup. This can save even more time and storage space than traditional block-level backups.
- **Snapshot-Based Backups:** leverage snapshot functionality to enable efficient backups. Snapshots capture a point-in-time copy of a dataset, allowing for consistent and reliable backups without disrupting ongoing operations.

- **Local Backup and Restore** enables the creation of local backups to safeguard data within the storage environment. Users can create snapshots of their datasets and clone them for offline storage, providing an additional layer of protection against accidental deletions, data corruption, or system failures.
- **Cloud Snapshot Backup** extends backup capabilities to the cloud. Users can take snapshots of their data and store them directly in the cloud, leveraging the cloud provider's infrastructure for secure off-site backups. Cloud snapshot backups provide an efficient and scalable solution for data protection in cloud environments.
- **Incremental Backups** capture only the changes made since the last backup. This approach minimizes storage and network overhead by transferring and storing only the modified data blocks. Incremental backups significantly reduce backup time and optimize storage utilization.
- **Write and Read Limits for Backup Operations** can be configured by setting specific bandwidth limits, to manage network resources and prioritize backup or restore operations based on user requirements.
- **Advanced Search and Metadata** provides advanced search capabilities for efficient backup management. Users can perform granular searches based on snapshot names, dates, or metadata. This feature simplifies the process of locating and retrieving specific backups, improving backup administration and recovery workflows.
- **Tar Format** supports tar archiving for backups. Users may choose the tar format when creating backups, ensuring compatibility and interoperability with other systems or tools that support the tar format. This flexibility enables seamless integration with existing backup and restore workflows.
- **Point-in-Time Recovery** leverages snapshot capabilities so users can roll back datasets to a specific snapshot, effectively restoring data to a previous state. This feature is particularly useful in scenarios where data corruption or accidental modifications need to be reversed.
- **Replication and Disaster Recovery** enables users to replicate datasets, including snapshots, to remote Oracle ZFS Storage systems, ensuring data redundancy and enabling rapid recovery in the event of a primary system failure.

Data Security and Compliance

Data security and compliance features of Oracle ZFS Storage provide encryption, auditing, logging, retention policies, and many other features to ensure the protection and regulatory compliance of data. Some of these features are highlighted below:

- **Role-Based Access Control (RBAC)** allows administrators to assign specific roles to users, granting them access to perform certain actions and manage resources based on their assigned roles.

Figure 10. Data Protection

ZFS Data Verification Read Only Snapshots

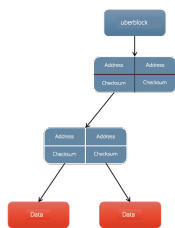

ZFS offers exceptional data protection and separates checksum from data increasing resiliency against low level attacks.

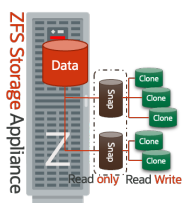

By design, snapshots are immune to ransomware encryption attempts and are preserved as read-only for R/W thin clones, for extra security.

Role Based Management

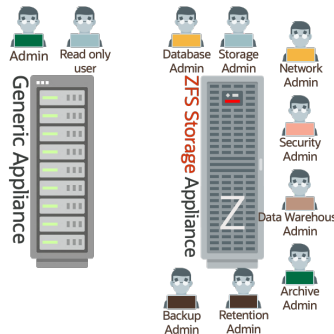

ZFS provides separation of powers with very granular rights management and creation of roles with the right level of access.

- **Active Directory Integration** enables integration with Active Directory, allowing users to authenticate and manage access to the Oracle ZFS storage system using their existing Active Directory credentials.
- **Secure Shell (SSH) Support** provides secure remote access for administrators to manage and configure the system.
- **Transport Layer Security (TLS) Support** ensures secure communication between clients and the storage system over the network.
- **Encryption at Rest** allows data to be encrypted on the storage devices. This feature ensures that even if the physical disks are compromised, the data remains encrypted and inaccessible.
- **Key Management** securely manages encryption keys. Users can leverage external key management solutions such as local or remote KMIP wrapping key storage to centrally manage and protect encryption keys, ensuring secure key storage and access control.
- **Data Integrity Checksums** verify the integrity of data stored on disks. This feature detects and corrects silent data corruption, providing an additional layer of data protection.
- **Access Control Lists (ACLs)** allow administrators to define fine-grained access permissions for files and directories, ensuring that only authorized users have access to specific resources.
- **Assured delete** allows securely deleting data by encrypting it with a key and then destroying the key. This ensures that the data cannot be recovered, even if the physical storage device is compromised.
- **Raw Crypto Replication** enables encrypted data to be securely replicated to another Oracle ZFS Storage system, maintaining data confidentiality during replication. It improves the security and efficiency of replicating encrypted data by avoiding both decrypting the data on the source appliance and re-encrypting it on the target appliance.
- **Read-Only Snapshots** provide a point-in-time view of the file system. These snapshots cannot be modified, providing an additional layer of protection against accidental or malicious changes to the data.
- **Ransomware Recovery** provides the capability to create recovery points specifically designed to protect against ransomware attacks. These recovery points are immutable and cannot be modified or deleted by normal operations, providing a reliable restore point to recover from in case of a ransomware incident. This feature helps safeguard data integrity and ensures the availability of clean data copies for recovery purposes.
- **Auditing and Logging** tracks user activities, system events and configuration changes. These logs can be used for forensic analysis, compliance audits and security monitoring.
- **Per File Audit** provides enhanced security measures by allowing enterprises to track and monitor individual-file level activities, ensuring compliance with data security and privacy regulations. This feature enables detailed auditing and logging of file access, modifications, and other relevant actions, allowing better visibility and control over data usage within Oracle ZFS Storage. By tracking file level activities, enterprises can identify and investigate any unauthorized access attempts, policy violations, or suspicious behavior, strengthening overall data security and compliance measures.
- **Retention policies** provide a flexible and automated approach to controlling the lifespan of snapshots, files, and objects based on specific criteria. With retention policies, users can set rules to determine how long these artifacts should be retained based on factors such as time intervals, snapshot count, or a combination of both. Retention is especially important for corporations that need to comply with certain regulations regarding electronic storage requirements from the Securities and Exchange Commission (SEC), Financial Industry Regulatory Authority (FINRA), and the European Union's Commission Delegated Regulation. A report released by [Cohasset Associates](#) details their opinion that the Oracle ZFS Storage Appliance is compliant with these regulations when using the appliance's file retention policies. You can download Cohasset's [Compliance Assessment report here](#).

Figure 11. Retention at 3 Levels

Object Retention Lock

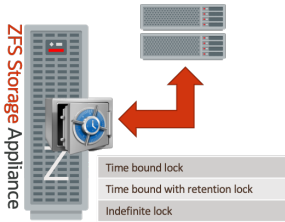

Snapshot Retention Lock

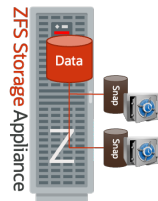

File Retention Lock

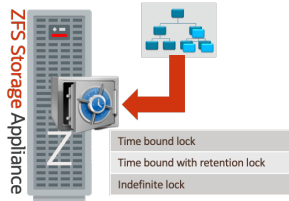

Several flexible retention lock features enable right level of protection for different data sets.

Supports both manual and automated immutable snapshots for protection against ransomware. Can enforce minimum number of snapshots to retain.

Mandatory file retention locks files for compliance with SEC 17a-4(f), FINRA 4511(c), and other record retention regulations.

Integration and Cloud Connectivity

Oracle ZFS Storage integration and cloud connectivity features enable seamless integration with cloud platforms, offering capabilities such as cloud backup, object storage integration, and S3 API support to leverage the benefits of cloud storage in the customer’s Oracle ZFS Storage environment.

- **Cloud Snapshot Backup to OCI Object storage** allows users to back up their full or incremental snapshots in on-premises Oracle ZFS Storage directly to OCI object storage. Moreover, it offers the ability to create an incremental cloud backup without requiring that its parent cloud backup is saved in the cloud. This then affects restore and delete operations for both the parent and incremental cloud backups. Notably, disassociating the incremental cloud backup from its parent enables the deletion of the parent cloud backup from the cloud target, thus saving space.
- **On Premises Object API for OCI Object Storage** enables seamless integration between the on-premises Oracle ZFS Storage and OCI Object Storage. It allows users to interact with and manage objects stored in OCI object storage directly from the on-premises Oracle ZFS Storage environment, facilitating data movement and synchronization between on-premises and cloud storage.
- **S3 API Service:** enables Amazon Simple Storage Service (S3) clients and applications to store content on an Oracle ZFSSA file system. The purpose of this API is to provide a fast and scalable object store repository that application developers can use to store blobs of data for easy access, much the way that web developers use Amazon S3 or Oracle Storage Cloud Service Object Storage. Other advantages of hosting an object storage repository on Oracle ZFS Storage include:
 - Reduced space consumption with compression and deduplication
 - Protection of sensitive data with encryption
 - Ability to snapshot, clone, and replicate objects
 - Integrated identity management
 - SWIFT interoperability - Both object storage protocols (OCI Object Storage and S3) share a common namespace, so objects and containers (buckets) created from one protocol are visible and editable from the other.

Oracle customers who already use Amazon S3 and Oracle ZFSSA get the flexibility of storing object data directly on Oracle ZFSSA in a private cloud environment. This combination of technology enables creation of a large, resilient object storage without the transparent box sprawl and management headaches of existing object storage configurations and results in excellent performance for critical workloads. It also offers:

- Offloading application development to local Amazon S3 storage on Oracle ZFSSA in customer's on-premises data center and then switching to traditional S3 (AWS) for production
- Offloading object data directly to an on-premises Oracle ZFSSA as a cost efficient, multipurpose storage platform

Automation and Customization

The automation and customization features in Oracle ZFS Storage enable users to streamline workflows, increase operational efficiency, and tailor the system to meet their specific needs.

- **Automatic Capacity Scaling in OCI** adds the ability of an Oracle ZFS Storage instance running on Oracle Cloud Infrastructure to automatically expand a storage pool when it reaches a specified percentage. The feature also provides an option to manually expand a pool by adding a disk or resizing an existing disk.
- **Flex Shape Scaling in OCI** allows customers to change the size of their ZFS instances after deployment. This is useful for customers who need to adjust the performance of their instances based on their workload requirements.
- **Custom Alerts for event-based workflows and scripts** enable event-based, reactive workflows and scripts that trigger specific actions, such as sending emails or SNMP traps, based on identified events during execution.
- **REST Login Tokens for alternative access to the RESTful API** allows users to apply alternative username and password access to the Oracle ZFS Storage's RESTful API. These tokens can be persistent or non-persistent, providing secure and flexible authentication options. Users can create, list, and delete tokens in various management interfaces, including the BUI, CLI, or REST interface.
- **Customized Banner in BUI/CLI for personalized messages** allows users to configure a personalized message that is displayed on the BUI before login and in the CLI after a successful login. It enables users to customize their user interfaces with specific messages or instructions, enhancing the overall user experience.

Performance and Observability

The performance and observability features in Oracle ZFS Storage enable users to gain comprehensive insights into their storage environment, leading to enhanced performance monitoring, bottleneck identification and efficient resource utilization.

- **Average Latency Statistics for protocol latency monitoring** provides granular observability for protocol latency by capturing average latency statistics for various protocols such as NFSv2-4.1, SMBv1-3, iSCSI, FC, and SRP. It allows users to troubleshoot latency issues and derive potential actions or alerts based on defined thresholds.
- **I/O Throttling for Filesystems to limit bandwidth usage** lets users set bandwidth read and write limits at the project or share level for filesystems. This feature enables control over the maximum bytes per second that can be read from or written to a share, providing I/O throttling capabilities to manage bandwidth usage effectively.
- **SAS Cabling Fault Diagnosis for detecting and resolving SAS cabling issues** helps identify various SAS cabling faults, including missing or extra cable connections, chain connections made to unexpected disk shelves, exceeding maximum chain length, invalid disk shelf combinations, unsupported disk shelf types, and missing IOMs. It assists in diagnosing and resolving SAS cabling issues for optimal system performance.

Enhancements and Usability

Oracle ZFS Storage offers the following key enhancements and usability features:

- **SNMP MIB enhancements for additional tables and improved status reporting** introduces new tables and enhances existing tables in the SNMP MIB files. The new tables include replica share status, storage pool status,

and hardware status, providing comprehensive information about these components. The enhancements improve cluster status and share status reporting for better visibility and monitoring.

- **Scrub Scheduling for background pool scrub with automated priority** allows users to schedule regular pool scrubs at specified intervals. Pool scrubs help identify and resolve data inconsistencies, and the automated priority tuning ensures efficient background scrubbing without impacting system performance. It enhances data integrity and availability by proactively detecting and resolving potential issues.
- **Username-based Default Directory for FTP Service:** , directs FTP users to their respective username-based home directories, instead of the default root directory . This feature improves user experience and simplifies file management within the FTP service.
- **LDAP Server Preference Order for preferred server selection** ensures that servers are selected in the specified order, enabling a more predictable and customizable LDAP server selection process. If the first server is unavailable, the subsequent servers are automatically chosen, facilitating seamless authentication and user access.

Use Cases

Oracle ZFS Storage is a versatile and robust storage solution that is being used across a wide variety of use cases in all industry sectors. Many customers are transitioning to a hybrid cloud model and leveraging Oracle ZFS Storage in Oracle Cloud Infrastructure (OCI) to reduce costs, improve performance, and increase agility.

Data Management and Protection

Unified Storage for Mixed Workloads

Oracle ZFS Storage is a versatile and sophisticated storage solution that can handle the complexities of block, file, and object storage.

Figure 12. Storage Types are like Parking Options

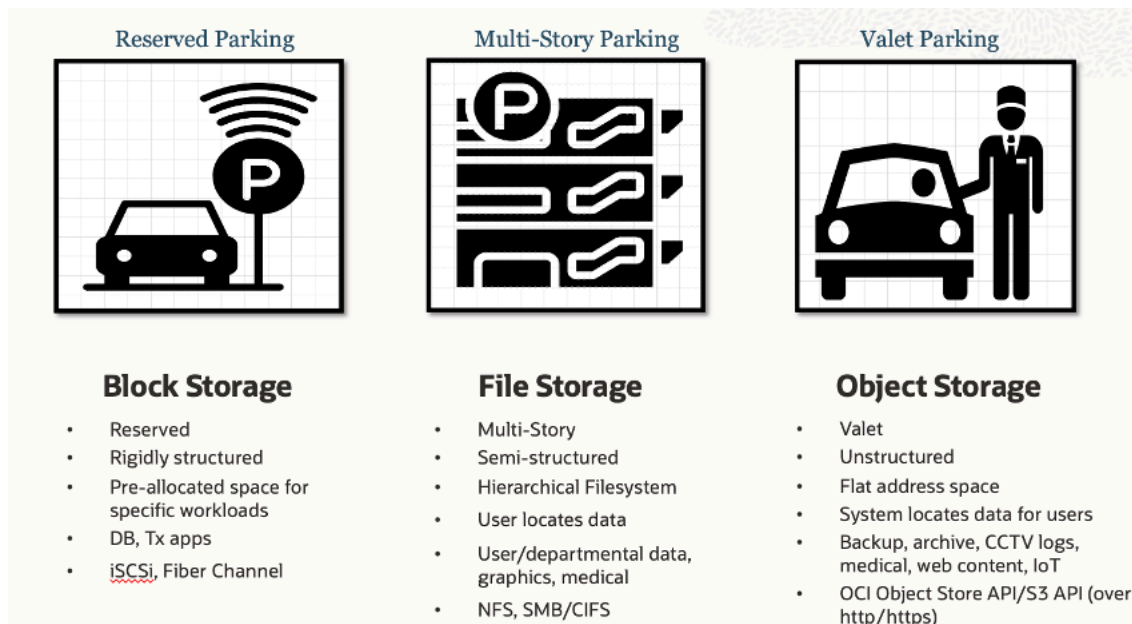

Block storage, analogous to a reserved parking space, provides dedicated and pre-allocated storage, ensuring consistent performance for specific tasks such as database storage. It is accessed through protocols such as iSCSI and Fiber Channel.

File storage, similar to a multi-story parking lot, uses a hierarchical file system to organize data into folders and subfolders, similar to how cars are parked on different levels of a parking garage. This structure is ideal for managing user data, images, and medical records. It is typically accessed through protocols such as NFS and SMB/CIFS, offering both flexibility and organization.

Object storage, comparable to valet parking, is tailored for unstructured data such as backups, archives, and IoT data. It provides a flat address space, enabling data storage and retrieval without relying on a traditional file system structure. Object storage typically uses APIs such as OCI Object Store API and S3 API over HTTP/HTTPS.

Oracle ZFS Storage unifies the management of these diverse workloads, providing a unified storage platform available both on-premises and in Oracle Cloud Infrastructure (OCI). The on-premises Oracle ZFS Storage Appliance has a unique capability: the ability to store object data directly on the appliance. This eliminates the need for external object storage connections and is facilitated through a built-in object store service that complies with industry-standard APIs. This capability allows users to efficiently manage various unstructured data directly on the appliance, such as images, videos, audio files, and documents. In OCI, the system leverages OCI block volumes to create the file system and seamlessly connects with OCI Object Store, providing a cohesive storage experience.

This integrated solution eliminates the need for disparate storage systems, ensuring efficient, secure, and accessible data management across diverse applications and use cases. The system seamlessly integrates data services, supporting file and block-level protocols with high-speed network connectivity and robust cloud object storage integration. Comprehensive data management features, including compression, deduplication, encryption, snapshots, replication, and fine-grain analytics, are the foundation of Oracle ZFS Storage's robust data protection and management capabilities.

Backup & Disaster Recovery and Data Migration

Backup & Disaster Recovery

Oracle ZFS Storage is an essential tool for data management, particularly in the critical areas of backup and disaster recovery (DR). Data loss can have devastating consequences for businesses, including financial losses, reputational damage, and legal action. Oracle ZFS Storage provides a robust backup and recovery solution, efficiently capturing data through space-efficient snapshots that serve as point-in-time copies. These snapshots facilitate rapid data restoration in the event of accidental deletion or corruption.

For large databases, Oracle ZFS Storage offers full, incremental, and differential backups, ensuring data protection even in the face of significant changes or growth. Incremental and differential backups minimize backup time and storage requirements by copying only the data that has changed since the last backup. To further strengthen data loss prevention, Oracle ZFS Storage supports offsite backup to cloud storage, such as Oracle Cloud Infrastructure Object Storage, providing an additional safeguard against physical disasters or site outages.

Oracle ZFS Storage particularly excels in database backups, offering the image copy backup feature that leverages snapshots to capture database states quickly and efficiently. This approach eliminates the need to copy the entire database file, resulting in significantly faster backup times compared to traditional RMAN backups that employ a block-based approach.

In contrast to image copy backups, RMAN backups employ a block-based approach, involving copying the data blocks that have changed since the last backup. While this method ensures data integrity, it can be more time-consuming, especially for large databases.

Oracle ZFS Storage's image copy backup feature is particularly beneficial for frequently updated databases or when rapid backup is essential. The ability to capture database states quickly using snapshots minimizes downtime and ensures data protection without compromising performance.

In conjunction with ZFS snapshots, Oracle ZFS Storage enables efficient point-in-time recovery, minimizing the impact of data loss or corruption. For mission-critical databases, the integration of Oracle ZFS Storage with Oracle's

Zero Data Loss Recovery Appliance (ZDLRA) ensures the highest level of data protection. ZDLRA continuously replicates data from Oracle ZFS Storage, maintaining a readily available copy for recovery in disaster scenarios.

Beyond backup, Oracle ZFS Storage plays a pivotal role in disaster recovery strategies. Its robust replication capabilities facilitate rapid data restoration after a disaster, providing a critical component for uninterrupted business operations. The platform supports flexible compute shapes, allowing businesses to scale resources to the cloud during peak demand or DR scenarios. Additional features such as snapshots, failover/failback capabilities, and automated recovery processes further enhance disaster recovery preparedness. Oracle ZFS - HA in OCI enables businesses to establish a disaster recovery environment entirely in OCI, eliminating the need for a second data center and delivering CAPEX savings.

Data Migration (Lift & Shift)

Data migration involves the seamless transfer of data between systems or storage environments, a process that has become increasingly crucial in today's data-driven world. Factors such as hardware upgrades, storage consolidation, compliance requirements, and transitioning to new cloud providers often necessitate data migration processes. Oracle ZFS Storage effectively addresses these complex data migration scenarios with its advanced snapshot and replication capabilities. By utilizing the Copy-on-Write (COW) technique, snapshots create incremental representations of existing datasets, minimizing storage consumption, and facilitating efficient data transfer. Replication further optimizes efficiency by transmitting only the data changed since the last replication, reducing network bandwidth usage and replication times.

Oracle ZFS Storage simplifies data migration across on-premises and cloud environments by eliminating the need for separate storage systems, streamlining data management, and enabling effortless movement between different locations. Enterprises can consolidate storage resources, optimize utilization, and reduce management overhead. Committed to storage and cost efficiency, Oracle ZFS Storage incorporates advanced compression and deduplication algorithms that work in tandem with Copy-on-Write (COW) to ensure that only necessary data is stored and replicated, leading to significant cost savings and efficient space utilization during data migration. The seamless integration of ZFS Storage with hybrid cloud architectures empowers organizations to leverage the advantages of both on-premises and cloud infrastructure, facilitating data movement between on-premises and cloud storage, and allowing organizations to balance cost-effectiveness, performance, and compliance requirements. ZFS Storage's support for multiple protocols in block, file, and object storage ensures flexibility and adaptability in diverse migration scenarios, enabling organizations to select the most appropriate protocol for their specific data type and environment, ensuring seamless data transfer and compatibility with existing infrastructure.

Additionally, ZFS Storage offers a unique shadow migration feature that enables data migration without disrupting access to production data. This feature allows organizations to migrate data to a new storage system without incurring downtime or performance impacts, making it an ideal solution for migrating critical production workloads.

Cloning Test/Dev Environments

Creating and maintaining test and development (test/dev) environments can be a costly and time-consuming endeavor. Traditional methods of copying and moving files between production and test/dev environments can be inefficient and error-prone, leading to delays in testing and potential defects in production environments. Businesses need a solution that empowers them to create and refresh multiple test/dev environments that mirror their production environments rapidly and effortlessly. Additionally, they need a cost-effective way to manage these environments to optimize resource allocation and minimize expenses.

Oracle ZFS Storage addresses these challenges with its snapshot and clone capability, which allows businesses to create full-size, writable clones of production data for use in test/dev environments. These clones consume no additional storage space until changes are made, ensuring efficient storage utilization and cost savings. This makes them an ideal solution for creating and managing large test/dev environments without incurring excessive storage expenses.

The pay-as-you-go (PAYG) model of Oracle Cloud Infrastructure (OCI) further enhances cost savings by enabling businesses to only pay for the resources they consume. This eliminates the need for upfront investments in hardware or software, allowing businesses to scale their test/dev environments as needed without incurring additional capital expenditures.

Data Archiving and Retention Management

Data archiving is the process of storing data for a long period of time, typically for compliance or historical reference. It is closely related to retention management, which defines policies to hold onto data for compliance or regulatory purposes. Data under retention management cannot be altered or deleted until the retention period expires.

Oracle ZFS Storage is a high-capacity and cost-effective storage solution for long-term data archiving. It features data compression and deduplication to optimize storage utilization and reduce the cost of storing large volumes of data.

Compliance mandates often require enterprises to retain certain types of data for a specified period, and this data must be readily accessible, unaltered, and secure. Oracle ZFS Storage provides the following capabilities to fulfill these requirements:

- Write once read many (WORM) capabilities allow data to be stored in a non-erasable, non-writable format for a specified period.
- Point-in-time snapshots facilitate version control and historical reference, and their immutability prevents alteration or deletion of data.
- End-to-end data integrity checks and automatic error correction ensure the data remains consistent and intact over time.
- Built-in encryption and access control mechanisms protect the data from unauthorized access.
- Data compression and deduplication efficiently store large amounts of data.
- Comprehensive audit trails track and log access to data, helping enterprises comply with auditing requirements.

Oracle ZFS Storage is an ideal solution for data retention needs, especially for enterprises in regulated industries or those that need to comply with legal requirements. It provides a reliable, secure, and efficient way to store data for long periods of time.

3rd Party Integration

Oracle ZFS Storage has a broad set of third-party integrations to enhance its capabilities and interoperability. Some key integrations are as follows:

- **Backup Software Integrations:** It integrates with various backup software solutions to provide comprehensive data protection such as Veritas NetBackup and Commvault.
- **Operating System Integrations:** It is OS agnostic and can handle many protocols including NFS, SMB, iSCSI, HTTPS, WebDav, and FTP/FTPS/SFTP.
- **Cloud Integrations:** It can integrate with cloud environments for hybrid deployments, backup, and DR purposes. Examples include Amazon S3, Oracle OCI and OpenStack Swift.

Note that while Oracle provides direct support and optimization for the above integrations, the open nature of Oracle ZFS Storage allows it to work with virtually any software that can communicate with storage over standard protocols.

Engineered Systems Storage

Oracle ZFS Storage is used as an engineered system storage for Oracle engineered systems such as Oracle Compute Cloud@Customer, Oracle Exadata Cloud@Customer and Oracle ZDLRA among others. It can be used as an external

storage for Oracle Exadata Cloud@Customer and Oracle ZDLRA and both as an internal storage and external storage for Oracle Compute Cloud@Customer.

Storage for Oracle Compute Cloud@Customer

Oracle Compute Cloud@Customer delivers the same OCI compute services using the latest server, storage, and networking technology to customers on-premises on a subscription basis while they are charged on a PAYG for resource usage. It enables them to develop applications once and run them anywhere. Oracle ZFS Storage is a critical component of this appliance and offers scalable on-box storage in the range of 150TB to 3.4PB. This can be further scaled up with external ZFS Storage whether on-premises or in OCI Marketplace and can support a variety of primary and secondary storage use cases.

Figure 13. Oracle Cloud@Customer with Embedded Oracle ZFS Storage



Oracle Exadata Backup to Oracle ZFS Storage via Direct Connection

Oracle Exadata Database Machine (Oracle Exadata) is a high-performance database system that underpins mission-critical applications. Oracle ZFS Storage Appliance offers a seamless 100Gb backup solution by directly connecting to the Exadata RoCE network fabric. This eliminates the need for a dedicated backup network and provides a local backup option that is optimized for performance and simplicity. The solution also eliminates the need for additional knowledge or skillset to maintain, as the Exadata RoCE network switches are managed as part of the Engineered System's hardware and software infrastructure.

Figure 14. Oracle Exadata X9M and Oracle ZFS Storage Appliance ZS9-2 100Gb backup solution overview

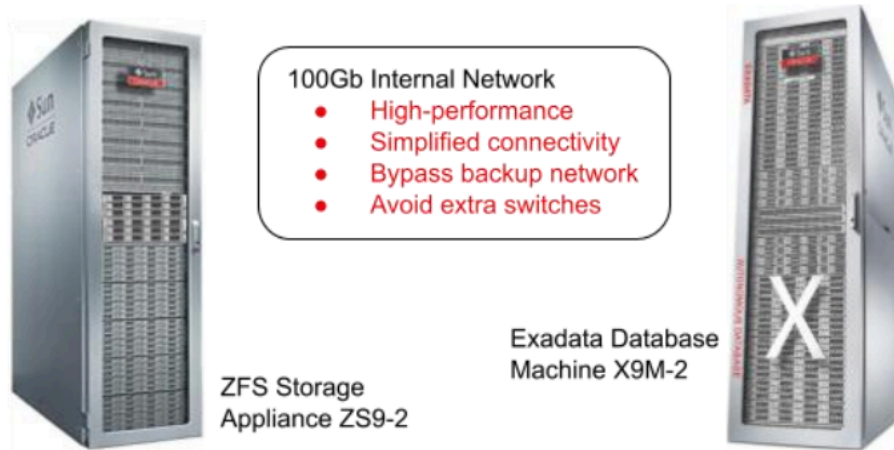

The Oracle ZFS Storage Appliance can achieve a maximum Oracle Recovery Manager (RMAN) backup rate of 52.3 TB/hr for an Oracle Exadata Database Machine attached to a ZS9-2 high-end with 6 high-capacity disk shelves. This rate was achieved in a lab environment using a double parity storage profile and an OLTP database populated with sample customer data. The database workload with a concurrent RMAN backup load still achieved 90.3% of the performance recorded on an idle system.

Figure 15. Oracle Database backup/restore maximum throughput rates for ZS9

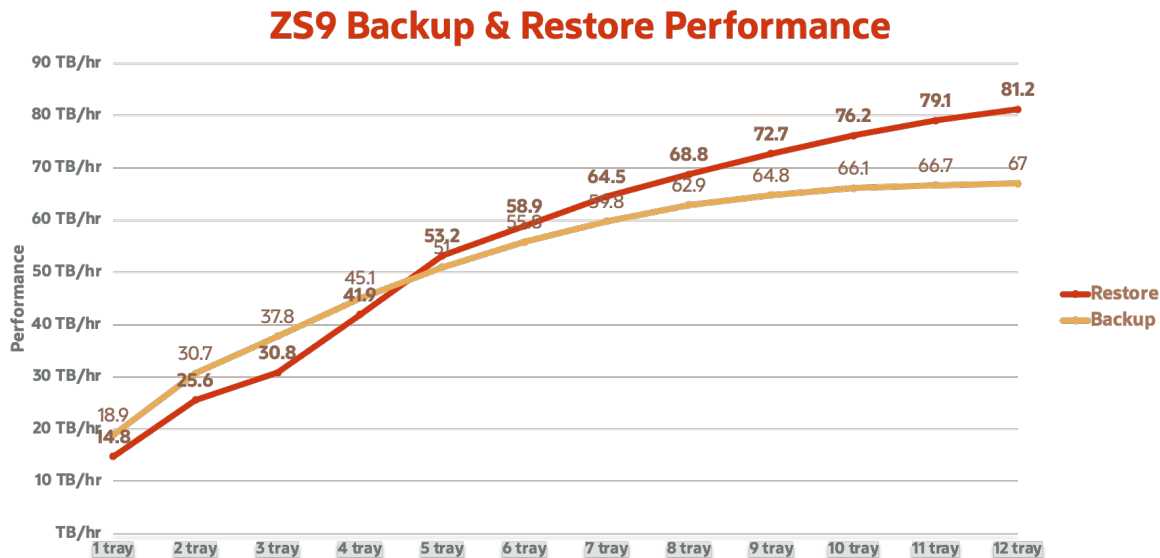

Oracle ZFS Storage Appliance incorporates a suite of advanced technologies that further enhance its performance and reliability. Large Receive Offload (LRO) aggregates multiple incoming packets into a single larger packet, reducing the overhead of processing small packets and improving performance. Active/Active Network Multipathing (IPMP) enables seamless failover between multiple network paths, ensuring continuous data availability even in the event of network disruptions. Oracle Recovery Manager (Oracle RMAN) integration optimizes backup and recovery operations by parallelizing I/O across multiple channels and controllers, while Oracle Database's Direct NFS Client feature allocates individual TCP connections for each Oracle Database process, reducing overhead and improving performance.

Archiving long-term retention backups from Zero Data Loss Recovery Appliance to Oracle ZFS Storage

Oracle ZDLRA is designed to provide the highest level of protection for Oracle Databases. Equipped with advanced features such as continuous protection through Real-Time Redo Transport and true Incremental Forever capabilities, it dramatically reduces Recovery Point Objectives (RPOs) and production backup overhead. For each incremental backup received, the appliance generates a new virtual full (Level 0) backup, readily available for any database restoration purposes.

While the Oracle ZDLRA excels in short to medium-term retention, typically up to 90 days, the requirement for long-term retention backups necessitates strategic archiving. In situations where accessing a public cloud location or utilizing a tape infrastructure is impractical, a local disk-based solution emerges as the optimal choice. The Oracle ZFS Storage Appliance, serving as a secondary storage tier, proves invaluable in extending the Recovery Appliance's recovery window or accommodating backups with extended retention periods.

Figure 16. Data Protection for Oracle Exadata with Oracle ZDLRA and Oracle ZFS Appliance

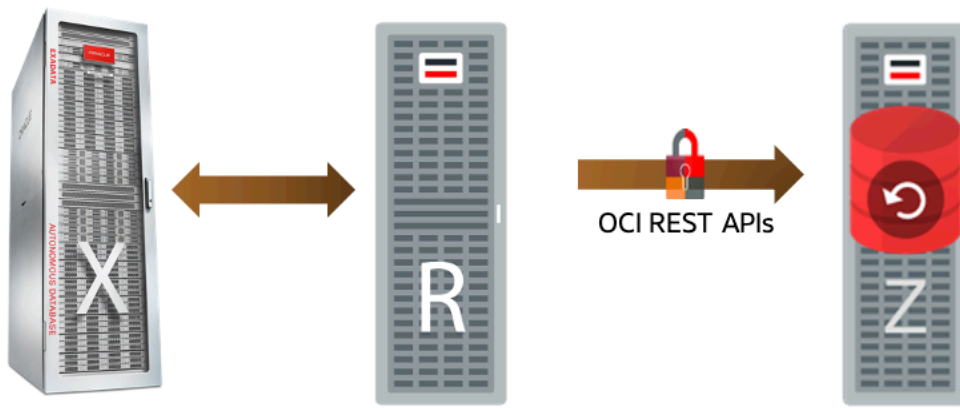

Archiving long-term retention backups from Oracle ZDLRA to Oracle ZFS Storage Appliance establishes a robust and efficient solution for safeguarding critical data. The Oracle ZDLRA, specifically designed for Oracle database protection, is the preferred option for Oracle Exadata Database. Leveraging the Oracle ZFS Storage Appliance enables enterprises to establish an on-premises, disk-based, long-term retention destination for Oracle ZDLRA backups, eliminating the reliance on tape-based storage.

The seamless integration between Oracle ZDLRA and Oracle ZFS Storage Appliance, facilitated by the OCI REST API, enhances isolation and eliminates the need for NFS mounts. Backups stored in native RMAN format can be restored with or without Oracle ZDLRA, ensuring flexibility and adaptability. The 25Gb Ethernet connectivity enables backup archiving and restoration at remarkable speeds of up to 24TB/hour.

Oracle ZFS Storage Appliance significantly extends the recovery window for long-term retention needs, guaranteeing that critical data remains accessible for extended periods. This compliance-friendly solution aligns with regulatory requirements and provides a cost-effective, integrated storage tier. Oracle ZDLRA encrypts and backs up data to both ZFS Storage Appliance and OCI, centralizing retention policy management on Oracle ZDLRA. Backups stored in OCI archives offer universal accessibility, and organizations can effortlessly accelerate their cloud migration journey by directly provisioning cloud databases from archive backups.

Database and Business Intelligence

Oracle Database, Data Warehouse and Business Intelligence

Oracle ZFS Storage offers extreme performance, scalability, and data protection capabilities, catering to both Oracle and non-Oracle databases. It supports a diverse range of Oracle and third-party databases, effectively handling a wide spectrum of workloads, including batch processing, data warehousing and analytics, and high-performance computing. Its tight integration with Oracle DB, coupled with advanced features like OISP, dNFS, HCC, and ADO, establishes it as the ideal choice for Oracle DB environments. Beyond Oracle DBs, ZFS Storage extends its reach to support a variety of third-party databases, encompassing critical areas such as high-performance backup and recovery, data cloning, storage of executables, and data protection for third-party software.

Data warehouses serve as repositories for historical data extracted from operational databases. Unlike operational databases, data warehouses store data in a denormalized format, optimized for analysis and querying. This design enables BI systems to rapidly process and retrieve massive datasets for reporting and analytics purposes. BI systems utilize data warehouse information to generate reports, dashboards, and other visualizations, empowering businesses to comprehend their operations, identify trends, and make informed decisions. Efficient and timely access to large volumes of data is crucial for BI systems. By providing ample caches and high-speed connectivity options, Oracle ZFS Storage addresses the data warehousing needs, ensuring swift access to vast amounts of data for analytics and reporting. Its support for various protocols and scalable storage capabilities make it a versatile solution for data warehousing workloads. Oracle ZFS Storage enables efficient data transfer and processing for BI applications by providing ample cache and connectivity capabilities. Its unified storage architecture and support for tiering and compression technologies ensure efficient storage and management of large datasets.

In-memory Databases

IMDBs offer exceptional speed, but they also bring forth unique challenges such as data durability and recovery, data integrity, storage utilization, and scalability. Oracle ZFS Storage is an ideal solution for in-memory databases, as it addresses these challenges with its innovative hybrid pool architecture. With a 4TB DRAM cache and high-speed data access, Oracle ZFS Storage ensures peak performance for in-memory databases from the start. It also provides a robust data protection framework with snapshots and replication, guaranteeing data integrity and swift recovery even in the event of system failures.

Oracle ZFS Storage also leverages compression and deduplication to optimize storage usage, making it a cost-effective solution for managing the persistent data characteristic of in-memory databases. Finally, its seamless scalability allows for the integration of additional storage resources without any downtime, meeting the evolving storage demands of in-memory databases.

HPC, AI/ML and Analytics

High-Performance Computing (HPC), Artificial Intelligence/Machine Learning (AI/ML), and Analytics workloads demand robust storage systems that can handle intensive data processing and complex computations swiftly and efficiently. These workloads generate and process large volumes of data that require high-speed data access and substantial storage capacity.

Oracle ZFS Storage is a robust storage system that can meet the demanding requirements of HPC, AI/ML, and Analytics workloads. It offers high-speed data access, high-capacity storage, data integrity, storage optimization, and support for multiple protocols.

In OCI, Oracle ZFS - HA can be coupled with powerful compute instances to create a scalable and high-performance platform for running HPC, AI/ML, and Analytics workloads. Additionally, integration with cloud services like Oracle Data Science and Oracle Analytics Cloud can further enhance the capabilities for AI/ML and analytics use cases.

Electronic Design Automation

Electronic Design Automation (EDA) involves processes such as design, verification, and testing of electronic systems and components, often involving large amounts of data and numerous small files. Oracle ZFS Storage excels at handling this type of data, as it can efficiently store and manage large numbers of small files. The following diagram depicts the [SPEC performance benchmark](#) for Oracle ZFS Storage ZS9-2 for the EDA workload.

Figure 17. SPEC Storage Performance Benchmark

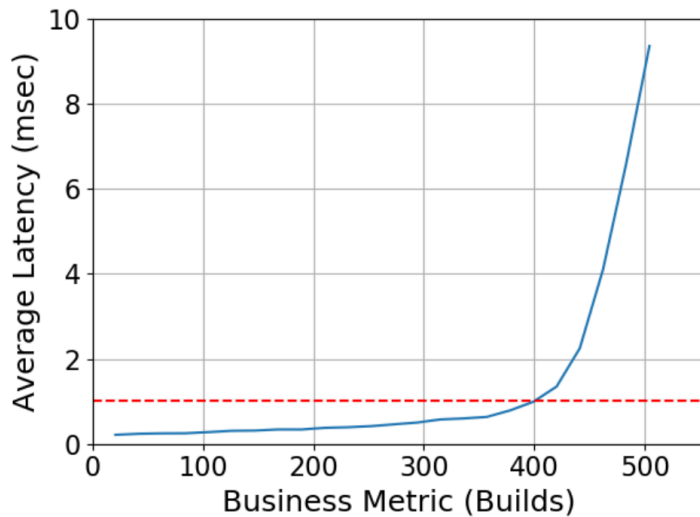

Oracle ZFS Storage is carefully designed to meet the strict requirements of EDA workflows, which often have many read and write operations happening at the same time. It uses checksums to carefully check for data errors, which is essential in EDA because designs must be very accurate. Oracle ZFS Storage easily works with NFS protocol up to version 4, a popular standard in the EDA industry. This makes it easy to use with existing workflows and applications. Quick recovery to a specific point in time and seamless duplication of datasets are very useful in EDA environments, making it easier to test and develop software thoroughly.

SAP Shared File System

Oracle ZFS Storage plays a crucial role in supporting SAP environments, meeting the demanding requirements of high performance, reliability, seamless NFS protocol support, and robust data protection. Its architecture ensures swift read/write operations, a critical need for SAP applications. Data integrity is safeguarded through end-to-end checksums, an essential feature for maintaining accuracy in SAP environments. The native support for NFS in Oracle ZFS Storage facilitates seamless integration with SAP applications using NFS for shared file systems. Additionally, its inherent scalability addresses the growing data volumes in SAP environments without compromising system performance. In terms of data protection, the snapshot and cloning features of Oracle ZFS Storage offer swift and effective backup and recovery mechanisms, mitigating the risk of data loss.

Oracle ZFS Storage can also handle large numbers of small files efficiently, which is another important requirement for SAP environments. SAP applications often generate large numbers of small files, such as log files, temporary files, and index files. The efficient data layout and metadata management capabilities of Oracle ZFS Storage allow it to handle these large numbers of small files without sacrificing performance.

A compelling [case study](#) is Loblaw, a prominent Canadian retailer with extensive operations. Loblaw migrated their SAP systems to OCI to modernize their IT infrastructure for scalable operations. With Oracle Exadata Database Service on OCI and Oracle ZFS - HA as their primary storage, Loblaw now manages one of the world's largest single-instance SAP databases, totaling over 180TB. The implementation across two regions, including a disaster recovery setup,

ensures business continuity. Choosing Oracle ZFS – HA instances for key components proved instrumental in delivering superior performance and handling large volumes of small files efficiently. According to their architect, Oracle ZFS - HA in OCI was indispensable, resulting in a remarkable 35% performance improvement. This successful integration underscores the pivotal role of Oracle ZFS Storage in supporting SAP environments, exemplifying its capability to deliver high-performance, reliability, robust data protection, and efficient handling of large numbers of small files.

Media Workflow Management

Oracle ZFS Storage handles the critical requirements for efficiently managing media content across its entire lifecycle. Media content management lifecycle encompasses four key phases: Content Repositories and Media Archives, Video Surveillance Storage, Media Rendering, and Content Delivery Network (CDN).

Content Repositories and Archives

Managing extensive libraries of media assets requires efficient access, enterprises, and long-term preservation. Oracle ZFS Storage addresses these needs with high-speed access, tiered storage options, and advanced data integrity measures. This ensures content creators can efficiently retrieve, organize, and safeguard their media assets. Additionally, Oracle ZFS Storage offers robust long-term retention capabilities. It provides features like the object retention lock and file retention lock, allowing administrators to set specific retention periods for critical objects. This ensures that valuable data remains unchanged and protected during the defined retention period, safeguarding against accidental or intentional deletion. These retention features also facilitate compliance with industry or regulatory requirements, avoiding penalties or fines for non-compliance. The snapshot retention lock feature enables the protection of crucial snapshots from accidental or intentional deletion. This includes support for both manual and automated immutable snapshots, providing an added layer of defense against threats like ransomware.

Video Surveillance Storage

Video surveillance is an essential component of media workflows in many industries, especially those where security and safety are critical. It enables real-time monitoring and recording of activities, aiding in incident prevention, investigation, and evidence collection. Oracle ZFS Storage delivers high performance for real-time video streaming and recording, even for high-definition footage, thanks to its multi-tier storage architecture. It can scale to meet the growing storage needs of video surveillance workloads, with support for petabytes of data and thousands of cameras. Features like deduplication and compression can significantly reduce storage requirements, making it an ideal choice for video surveillance workloads with large volumes of data. Robust data protection features, such as snapshots, replication, and erasure coding, ensure that video surveillance footage is always available and protected from loss or corruption.

Media Rendering

Media rendering is an intensive process that involves complex computations and data-intensive operations to generate audiovisual content such as graphics and animations. Oracle ZFS Storage offers high-performance storage capabilities and efficient data management for the storage-intensive media rendering process. Its advanced caching and intelligent data placement algorithms optimize read and write operations, improving overall rendering performance. Oracle ZFS Storage also provides check summing and self-healing capabilities to ensure data integrity and prevent silent data corruption, which is crucial for maintaining the quality and reliability of rendered data. Media rendering is a collaborative process, and the snapshot and clone features of Oracle ZFS Storage enable efficient creation of copies for collaboration, versioning, and backup purposes, reducing the time and storage required for media rendering. As media workloads grow, Oracle ZFS Storage can be scaled to accommodate seamless expansion. Integration with other media processing tools and applications allows for streamlined workflows, efficient data transfer, and seamless collaboration between different stages of the media rendering process.

Content Delivery Network

Content delivery networks (CDNs) are geographically distributed networks of servers that deliver web content to users with low latency and high availability. Oracle ZFS Storage is a well-suited storage solution for CDNs due to its low latency, high availability, flexibility, and scalability. Efficient data layout and ability to optimize performance for sequential and random read/write operations enable Oracle ZFS Storage to deliver low latency for CDN content delivery. Additionally, data check summing, self-healing, and redundancy features ensure high availability. Oracle ZFS Storage is also highly scalable, making it a good choice for CDNs that need to support high volumes of traffic. Oracle ZFS Storage is available both on-premises and in Oracle Cloud Infrastructure (OCI), offering CDN providers a choice of deployment options to meet their specific requirements. OCI provides a global network of data centers, high-performance infrastructure, and advanced security features. Major CDN providers, video streaming services, and gaming companies are already using Oracle ZFS Storage to deliver high-quality content to their users.

Virtualization and Cloud Solutions

Secondary Storage for Oracle VMware Solution

For enterprises that rely on Oracle VMware infrastructure, Oracle ZFS Storage emerges as an indispensable secondary storage solution, complementing Oracle's software expertise with VMware's virtualization technology. Whether deployed on-premises or in Oracle Cloud Infrastructure (OCI) environments, Oracle ZFS Storage addresses specific requirements that enhance the overall storage infrastructure.

Seamless integration with Oracle VMware environments enables Oracle ZFS Storage to effectively augment storage capacity and performance. This storage system optimizes data management through features like snapshots, cloning, and replication, ensuring efficient backup and disaster recovery strategies. Additionally, Oracle ZFS Storage's support for hybrid cloud configurations facilitates seamless data migration, providing flexibility and scalability to adapt to evolving business needs.

Oracle ZFS Storage excels in efficiently creating and storing VM data backups, replicating data to remote sites for robust disaster recovery, and enabling the segregation of frequently accessed VM data onto faster storage tiers, thus optimizing overall application performance. This storage system seamlessly expands capacity without disrupting VM operations, ensuring it can adapt to the growing data demands of VM workloads.

Distributed Cloud Storage

Distributed Cloud Storage has become an essential component of modern data management approaches. dispersing data across multiple geographical locations to ensure redundancy, accessibility, and enhanced performance. This approach, vital for data durability and resilience, demands seamless data replication and distribution across diverse locales. Security, scalability, redundancy, and consistent performance are critical aspects in intricate distributed storage setups.

Oracle ZFS Storage proves to be a holistic solution that smoothly caters to the requirements of distributed cloud storage. Available both on-premises and within Oracle Cloud Infrastructure (OCI), Oracle ZFS Storage excels in efficient data replication and distribution, incorporating features like remote replication for synchronized updates across diverse locations. It is purposefully designed to uphold data integrity with checksums, ensuring secure data transmission and storage. With inherent scalability, ZFS Storage allows for straightforward capacity expansion, and robust mechanisms like RAIDZ, mirroring, and snapshots ensure high availability and prevent data loss. The adept caching mechanisms and a hybrid storage pool design in ZFS Storage effectively address the challenge of maintaining consistent performance across varying network latencies, ensuring uniform, high-performance data access regardless of geographical disparities.

Virtual Machine Storage

Virtual machine (VM) storage is used to store the VM's operating system, applications, and data. It is a critical component of virtualized computing environments, as it provides the foundation for running and managing VMs. VM

storage encompasses both the storage space required to store the VM's files and the mechanisms and protocols used to access and manage that storage. It can be located on various types of storage devices, including hard drives, solid-state drives (SSDs), and network-attached storage (NAS) systems.

Efficient VM storage management is crucial for ensuring optimal performance and availability of virtualized applications. It involves tasks such as provisioning storage resources, managing data replication and backup, and implementing data protection strategies.

Oracle ZFS Storage is a robust solution designed to meet the demands of VM storage, whether on-premises or in the Oracle Cloud Infrastructure (OCI). It offers high performance, scalability, comprehensive data protection features, and efficiency tools, making it a well-suited choice for VM deployments of all sizes. Additionally, Oracle ZFS Storage enables quick provisioning and cloning of VMs, enhancing development and deployment processes.

Network Attached Storage and Storage Area Network

Network Attached Storage (NAS)

Enterprises with diverse data types such as user data, departmental data, graphics, and more, require a centralized and easily accessible file storage solution. Oracle ZFS Storage addresses this need by providing a powerful Network Attached Storage (NAS) solution. It supports protocols like NFS and SMB/Common Internet File System (CIFS), enabling efficient file sharing, access, and management across the network. With seamless integration of data services, robust data protection features, and high-speed network connectivity, ZFS Storage is the ideal choice for enterprises seeking a versatile NAS solution.

Storage Area Network (SAN)

Enterprises handling critical applications, databases, and transactional systems require high-performance, low-latency access to data through block-level storage. Oracle ZFS Storage caters to these demanding requirements with its tailored Storage Area Network (SAN) solution. By utilizing protocols like iSCSI (Internet Small Computer System Interface) and Fibre Channel, it provides the necessary performance and low-latency access required by critical systems. The seamless integration with SAN infrastructures, combined with comprehensive data management features, makes ZFS Storage the preferred choice for enterprises in need of efficient and reliable SAN solutions.

In NAS and SAN environments alike, rapid read/write operations are crucial. Oracle ZFS Storage employs a hybrid storage pool architecture, integrating DRAM, L2ARC, and ZIL to deliver exceptional performance. Scalability is imperative as data volumes surge within NAS and SAN environments. The innate scalability of Oracle ZFS Storage addresses this need effectively, accommodating expanding data volumes without compromising performance.

Virtual Desktop Infrastructure

Virtual Desktop Infrastructure (VDI) has transformed the way organizations deliver desktops to their users, offering a centralized, secure, and flexible solution for remote work and geographically dispersed teams. However, VDI environments demand a robust storage infrastructure that can meet the performance requirements, scalability needs, and data protection demands of a large number of users and their diverse workloads. Oracle ZFS Storage emerges as the ideal partner for VDI, providing a comprehensive suite of features tailored to address the specific challenges of VDI environments.

VDI environments face unique storage challenges due to the sheer number of virtual desktops and the varied workloads they support. To ensure a seamless user experience, VDI requires high-performance storage that can deliver fast data access, low latency, and consistent performance. Additionally, VDI environments must be scalable to accommodate a growing number of users and their desktops without compromising performance. Finally, data protection is paramount in VDI, as data loss or corruption can significantly impact users' productivity and the enterprise's overall operations.

Oracle ZFS Storage tackles the storage challenges of VDI head-on, providing a powerful combination of performance, scalability, and data protection. Its advanced storage pool design leverages SSD caching for rapid data access and



HDDs or other high-capacity storage devices for bulk storage, ensuring optimal performance and efficient storage utilization. ZFS Storage's scalability enables it to seamlessly expand as the VDI environment grows, accommodating an increasing number of virtual desktops without compromising performance.

Rapid provisioning, also known as instant cloning or copy-on-write (COW) cloning, is a critical capability for VDI environments. It enables the rapid creation of new virtual desktops from a template or base image, allowing for quick deployment and provisioning of desktops to new users or as part of maintenance procedures. ZFS Storage's advanced snapshot and cloning capabilities excel in rapid provisioning, enabling the creation of new virtual desktops in a matter of seconds, significantly reducing deployment time and improving user experience.

Whether deploying Windows-based or Linux-based virtual desktops, Oracle ZFS Storage provides the foundation for a successful VDI implementation, enabling enterprises to deliver a secure, flexible, and performant desktop experience to their users, regardless of their location or device.

Conclusion

Oracle ZFS Storage is a best-of-breed storage solution, providing exceptional performance, scalability, and flexibility. It offers a robust and versatile storage solution that caters to the diverse requirements of modern enterprises. With its seamless integration of on-premises and cloud storage architecture, support for multiple storage protocols, data protection capabilities, data services and networking features along with superior data management capabilities and 3rd party integrations, it enables enterprises to address a multitude of use cases.

Connect with us

Call +1.800.ORACLE1 or visit [oracle.com](https://www.oracle.com). Outside North America, find your local office at: [oracle.com/contact](https://www.oracle.com/contact).

 blogs.oracle.com

 facebook.com/oracle

 twitter.com/oracle

Copyright © 2023, Oracle and/or its affiliates. This document is provided for information purposes only, and the contents hereof are subject to change without notice. This document is not warranted to be error-free, nor subject to any other warranties or conditions, whether expressed orally or implied in law, including implied warranties and conditions of merchantability or fitness for a particular purpose. We specifically disclaim any liability with respect to this document, and no contractual obligations are formed either directly or indirectly by this document. This document may not be reproduced or transmitted in any form or by any means, electronic or mechanical, for any purpose, without our prior written permission.

Oracle, Java, MySQL, and NetSuite are registered trademarks of Oracle and/or its affiliates. Other names may be trademarks of their respective owners.

Oracle ZFS Storage: The Best-of-Breed Solution for Highly Scalable Oracle Cloud

Author: Sheetal Sabharwal